

NASA/TP-2001-210665

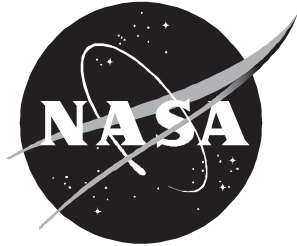

Simulator Evaluation of Airborne Information for Lateral Spacing (AILS) Concept

*Terence S. Abbott and Dawn M. Elliott
Langley Research Center, Hampton, Virginia*

March 2001

The NASA STI Program Office . . . in Profile

Since its founding, NASA has been dedicated to the advancement of aeronautics and space science. The NASA Scientific and Technical Information (STI) Program Office plays a key part in helping NASA maintain this important role.

The NASA STI Program Office is operated by Langley Research Center, the lead center for NASA's scientific and technical information. The NASA STI Program Office provides access to the NASA STI Database, the largest collection of aeronautical and space science STI in the world. The Program Office is also NASA's institutional mechanism for disseminating the results of its research and development activities. These results are published by NASA in the NASA STI Report Series, which includes the following report types:

- **TECHNICAL PUBLICATION.** Reports of completed research or a major significant phase of research that present the results of NASA programs and include extensive data or theoretical analysis. Includes compilations of significant scientific and technical data and information deemed to be of continuing reference value. NASA counterpart of peer-reviewed formal professional papers, but having less stringent limitations on manuscript length and extent of graphic presentations.
- **TECHNICAL MEMORANDUM.** Scientific and technical findings that are preliminary or of specialized interest, e.g., quick release reports, working papers, and bibliographies that contain minimal annotation. Does not contain extensive analysis.
- **CONTRACTOR REPORT.** Scientific and technical findings by NASA-sponsored contractors and grantees.
- **CONFERENCE PUBLICATION.** Collected papers from scientific and technical conferences, symposia, seminars, or other meetings sponsored or co-sponsored by NASA.
- **SPECIAL PUBLICATION.** Scientific, technical, or historical information from NASA programs, projects, and missions, often concerned with subjects having substantial public interest.
- **TECHNICAL TRANSLATION.** English-language translations of foreign scientific and technical material pertinent to NASA's mission.

Specialized services that complement the STI Program Office's diverse offerings include creating custom thesauri, building customized databases, organizing and publishing research results . . . even providing videos.

For more information about the NASA STI Program Office, see the following:

- Access the NASA STI Program Home Page at <http://www.sti.nasa.gov>
- Email your question via the Internet to help@sti.nasa.gov
- Fax your question to the NASA STI Help Desk at (301) 621-0134
- Telephone the NASA STI Help Desk at (301) 621-0390
- Write to:
NASA STI Help Desk
NASA Center for AeroSpace Information
7121 Standard Drive
Hanover, MD 21076-1320

NASA/TP-2001-210665

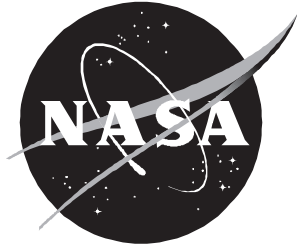

Simulator Evaluation of Airborne Information for Lateral Spacing (AILS) Concept

*Terence S. Abbott and Dawn M. Elliott
Langley Research Center, Hampton, Virginia*

National Aeronautics and
Space Administration

Langley Research Center
Hampton, Virginia 23681-2199

March 2001

Acknowledgments

The authors gratefully acknowledge the significant contributions of the many members of the research and development team, both Government and Industry, that were required to implement this concept and conduct the simulation test. With respect and gratitude we offer tribute to the pioneers of the AILS concept, Leonard Credeur, Charlie Scanlon, Marvin Waller, Gary Lohr, and Bill Capron. Also deserving of credit are the other members of the Langley AILS development team, R. Brad Perry, Phil Brown, Laura Rine, and Donner Grigsby, as well as the contractor counterparts, from Lockheed Martin Engineering & Sciences Corporation, Jake Barry, Dan Burdette, and Frank McGee; retired United Airline Captains, William Gifford and Dave Simmon; and from Adsystem, Inc., Thomas Doyle. Much appreciation is also extended to Honeywell, Inc., specifically, Bill Corwin, Dave Maahs, Jarold Weiser, Paul Samanant, Mike Jackson, Scott Snyder, and Christine Haissig, for taking an interest in the AILS concept and working to make this research a success. Many other persons whose names are not mentioned here have contributed significantly, and the authors express their sincerest thanks. The authors are only reporting the results of this study; the research, development, and implementation team members are what made this report possible.

Available from:

NASA Center for AeroSpace Information (CASI)
7121 Standard Drive
Hanover, MD 21076-1320
(301) 621-0390

National Technical Information Service (NTIS)
5285 Port Royal Road
Springfield, VA 22161-2171
(703) 605-6000

Contents

List of Tables v

List of Figures v

Nomenclature vii

Abstract 1

Introduction 1

Concept Overview 2

 Reducing the Intrusion Risk 2

 Navigation Source 2

 Lateral Path Boundary Design 2

 Pilot Alerting 3

 Guarding Against the Intruder 3

General Operational and Pilot Procedures 3

 Loss of AILS Capability 4

 Potential Loss of Lateral Separation 4

 Emergency Escape Maneuver 4

Hardware Architecture 5

Alerting Algorithm Description and Associated Displays 5

 Localizer Alerts 6

 Path Alerts 6

 Traffic Alerts 7

 Alert Priority and Sequence 8

Evaluation Design and Conditions 8

 Test Subjects 9

 Independent Variables 9

 Intruder Geometry and Relative Speeds 9

 Aircraft Control Modes 10

 Intruder Runway 10

 Pilot Run Matrix 10

 Aircraft Simulator 11

 TCAS Integration 11

 Traffic Generation 11

 Air Traffic Control Simulation 11

 Pilot Training and Evaluation Sequence 12

 Initial Conditions 12

Results 13

 Quantitative Results 13

 Miss-Distance 14

 Pilot Reaction Time 14

Qualitative Results	14
Scaled, Discrete Questions.....	14
Free-Response Questions.....	16
Summary of Results	17
References	19
Figures	20
Appendix A—Classroom Briefing.....	32
Appendix B—Flight Manual Bulletin	42
Appendix C—Simulator Briefing and Training Script	45
Appendix D—Quantitative Data Analysis Details.....	54
Appendix E—AILS Pilot Questionnaire	57

List of Tables

Table 1. AILS Alerting Table and Alerting Description	5
Table 2. Run Matrix for Pilot 1	10
Table 3. Slant-Range Miss-Distance	13
Table 4. Pilot Reaction Times (sec)	13
Table 5. Summary Statistics for Responses to Questionnaire Questions 1 Through 8, 11, and 12	15
Table 6. Summary Statistics for Responses to Questions 13–16	17

List of Figures

Figure 1. Parallel ILS approaches to runways spaced 2500 ft apart. Drawing not to scale	20
Figure 2. Example of constant-width approach design to two closely spaced parallel runways	20
Figure 3. Example of nonoverlapping, ILS-lookalike approaches using single 4° offset	20
Figure 4. Example of nonoverlapping, ILS-lookalike approaches using dual 2° offsets	20
Figure 5. Example of 2° offset approach to right parallel runway (offset is to right side).	21
Figure 6. Example of AILS instrument approach chart	22
Figure 7. Candidate hardware architecture.	23
Figure 8. Example of localizer advisory alert	23
Figure 9. Determining at-fault collision potential of ownship	24
Figure 10. Example of PATH caution alert on EADI and ND.	25
Figure 11. Example of PATH warning alert on EADI.	26
Figure 12. Determining the intrusion threat	26
Figure 13. Example of TRAFFIC caution alert on EADI and ND.	27
Figure 14. Example of TRAFFIC warning alert on ND.	28
Figure 15. Langley Integration Flight Deck layout	28
Figure 16. Center console layout	29
Figure 17. Langley Integration Flight Deck Simulation and Langley Research System Integration Laboratory layout	30
Figure 18. Slant-range miss-distance	30
Figure 19. Pilot reaction time	31
Figure 20. Distribution of responses to question 9.	31
Figure 21. Distribution of responses to question 10.	31

Nomenclature

A/C	aircraft
ACAR	automatic communications and recording system
ADS-B	Automatic Dependent Surveillance Broadcast
AFE	above field elevation
AGL	above ground level
AILS	Airborne Information for Lateral Spacing
A/P	autopilot
APP	approach
ARINC	Aeronautical Radio Incorporated
ATC	Air Traffic Control
C	Captain
CASPER	Closely Spaced Parallel Approaches
CDI	Course Deviation Indicator
CDU	control display unit
CRT	cathode-ray tube
CWS	control wheel steering
DGPS	differential GPS
DH	decision height
DME	distance-measuring equipment
EADI	Electronic Attitude Director Indicator
EEM	emergency escape maneuver
evader	properly maneuvering aircraft being threatened by another aircraft with collision
F	f-factor
FAA	Federal Aviation Administration

FAC	final approach course
FAF	final approach fix
F/D	flight director
FMS	Flight Management System
F/O	First Officer
GA	go-around
GPS	global positioning system
HSI	horizontal situation indicator
IFD	Langley Integration Flight Deck
IFR	instrument flight rules
ILS	instrument landing system
intruder	improperly maneuvering aircraft that produces collision risk to another aircraft
KIAS	knots indicated airspeed
MANOVA	multivariate analysis of variance
MAP	missed approach point
MCP	mode control panel
MD	miss distance
MIC	microphone
N	number
NASA	National Aeronautics and Space Administration
ND	navigation display
NM	nautical mile
NMAC	near midair collision, where aircraft is within 500 ft of another aircraft
ownship	from a flight crew's perspective, aircraft that they are flying
P	probability

PF	pilot flying
PFD	primary flight display
PNF	pilot not flying
PRM	Precision Runway Monitor
RA	resolution advisory
RSIL	Langley Research System Integration Laboratory
RTO	rejected takeoff
SOP	standard operating procedures
T	value from t-test
TA	traffic advisory
TCAS	Traffic Alert and Collision Avoidance System
TO	takeoff
VFR	visual flight rules
VNAV	vertical navigation

Abstract

The Airborne Information for Lateral Spacing (AILS) concept is designed to support independent parallel approach operations to runways spaced as close as 2500 ft. This report describes the AILS operational concept and the results of a ground-based flight simulation experiment of one implementation of this concept. The focus of this simulation experiment was to evaluate pilot performance, pilot acceptability, and minimum miss-distances for the rare situation in which an aircraft on one approach intrudes into the path of an aircraft on the other approach. Results from this study showed that the design-goal mean miss-distance of 1200 ft to potential collision situations was surpassed with an actual mean miss-distance of 2236 ft. Pilot reaction times to the alerting system, which was an operational concern, averaged 1.11 sec, well below the design-goal reaction time of 2.0 sec. These quantitative results and pilot subjective data showed that the AILS concept is reasonable from an operational standpoint.

Introduction

In recent years, airport runway construction within the United States has not been able to keep pace with the rise in traffic growth; this has resulted in an increase in both the number and duration of flight delays. In addition, many U.S. airports depend on parallel runway operations to meet the growing demand for day-to-day operations. In the current airspace system, poor weather conditions reduce the capacity of closely spaced parallel runway operations. These capacity losses can result in landing delays causing inconveniences to the traveling public, interruptions in commerce, and increased operating cost to the airlines. The Federal Aviation Administration (FAA) has addressed this reduced capacity problem for closely spaced parallel runways in its Precision Runway Monitor (PRM) Program (ref. 1). With ground-based radar technology consisting primarily of high update rate, more accurate radar, and higher resolution displays for Air Traffic Control (ATC) stations, PRM has certified capabilities to operate independent parallel approaches to runway separations as close as 3400 ft.

To further exploit independent parallel runway operations at airports with runway spacing below 4300 ft, the National Aeronautics and Space Administration has developed a flight deck centered concept that may allow operations below the current PRM runway separation minima. This new concept is called Airborne Information for Lateral Spacing (AILS) and is designed to support independent parallel approach operations to runways spaced as close as 2500 ft. This report describes the current AILS operational concept and the results of a ground-based flight simulation experiment of one implementation of this concept. The focus of this simulation experiment was to evaluate pilot performance, pilot acceptability, and minimum miss-distances for the rare situation in which an aircraft on one approach intrudes into the path of an aircraft on the other approach.

This effort was conducted under the Terminal Area Productivity Program of the NASA Aviation System Capacity Project. Avionics hardware development and integration to support the AILS concept was provided by Honeywell, Inc. under a cooperative agreement.

Concept Overview

The Airborne Information for Lateral Spacing (AILS) concept is an operational, procedures-based technique, along with appropriate supporting technologies, for conducting independent, simultaneous approaches to closely spaced parallel runways. For suitably equipped aircraft with eligible crews, AILS is very similar to today's typical instrument approach operations. AILS only becomes truly obvious to the flight crew when an extremely unusual event occurs: one aircraft flies off path and threatens the safety of another.

The AILS concept focuses on two aspects of the closely spaced parallel approach problem. First, approach paths must be designed and flown such that the possibility of one aircraft on one approach interfering with another aircraft on the other approach is remote. Second, if this remote event does occur, a means must be provided that will allow the nonoffending aircraft to safely avoid the intruding aircraft. How AILS accommodates both these operational aspects of the closely spaced parallel approach problem is described in the following sections.

Reducing the Intrusion Risk

The primary means for safely conducting simultaneous, independent instrument approaches to closely spaced parallel runways is through approach design and flight operations that would reduce the possibility of one aircraft intruding into the approach path of another. To accomplish this, the AILS concept requires a highly accurate navigation source, an approach path design that minimizes the potential for intrusions, and pilot alerting for situations that would generate a collision risk.

Navigation Source

From a navigation sensor standpoint, the AILS concept assumes the use of differential global positioning system (DGPS) or a navigation source with an equivalent level of accuracy and precision. The use of a standard instrument landing system (ILS) was not considered to be adequate due to course "bends" and other navigation anomalies that are not unusual to a typical ILS installation.

Lateral Path Boundary Design

From the approach design standpoint, straight-in, parallel approaches using standard ILS design were considered to be unacceptable for an AILS operation due to lateral path boundary overlap. (See fig. 1.) For a typical arrangement with runways spaced 3400 ft apart, lateral path boundary overlap would occur approximately 6 nmi from the runway thresholds. For a 2500-ft runway separation, the overlap would occur approximately 4 nmi from the thresholds. The problem with even the 3400 ft separation is that at 6 nmi, two aircraft could be operating legally within their respective approach paths and yet pose a collision threat to each other. One means to alleviate this problem would be to use nonangular lateral path boundaries. Previous AILS studies (ref. 2) used a constant-width path along the portion of the approach where the parallel approach aircraft could be at similar altitudes. In the example shown in figure 2, a minimum 1000 ft of vertical separation would be maintained beyond 10 nmi from the runway. At this distance, a 2000-ft path width would be used to accommodate normal intercept errors while acquiring the final approach course. Within 10 nmi of the runway, the vertical profiles for each approach were the same.

For the near future, two significant issues significantly diminish the potential for using the constant-width approach paths described previously. First, current production DGPS-based approach systems

mimic, from an approach design standpoint, conventional ILS approaches. In simple terms, the processing and signal output from the airborne DGPS hardware appears as a “perfect” ILS to the other systems on the aircraft and the approach is flown much like a conventional ILS. This type of DGPS implementation is known as an ILS-lookalike. The second issue with constant-width approach paths is that many older generation autopilots may not be able to track these paths without unacceptable lateral tracking oscillations.

One alternative that would allow for the use of DGPS ILS-lookalike approaches while eliminating the lateral path boundary overlap is an offset approach path. In this alternative, one or both of the lateral paths to the parallel runways would be angularly offset or slewed such that the inner path boundaries between the two approach paths would be parallel. (See figs. 3 and 4.) For this study, it was determined that the more challenging option of this alternative would be to slew both approaches 2° away from the opposite approach. The lateral path design for a right-side runway is shown in figure 5. The left-side runway is a mirror image of this figure, with the offset to the left. There are two operational disadvantages to offset approaches. First, there is a penalty in the decision height. In the design used for this study, this penalty was 50 ft, resulting in a 250-ft decision height for a nominally configured runway. The second problem is that the offset approach requires the pilot to manually turn the aircraft onto the runway centerline during a critical phase of flight, thereby adding to pilot workload. Although neither of these disadvantages is overwhelming, they can add to the operational “cost” of the AILS concept.

Pilot Alerting

The AILS concept uses two distinctly different classes of alerts for aircraft whose poor approach path tracking performance may produce a collision risk. The first class is a simple set of lateral path error alerts. That is, alerts are generated when an aircraft deviates farther than one half the width of the lateral boundary and also when the lateral boundary has been exceeded. The second class of navigation alerts is the potential-collision alerts that are generated when the maneuvering of your aircraft places another aircraft at risk. A detailed explanation of these alerts is provided in the section “Alerting Algorithm Description and Associated Displays.”

Guarding Against the Intruder

In the remote event that an aircraft on the parallel approach turns off its path and threatens an aircraft on the other approach with a potential collision situation, alerts are provided to the threatened aircraft.

General Operational and Pilot Procedures

As stated previously, an AILS approach would be very similar to today’s typical ILS approach operation. Like today, flight crews would conduct an approach briefing using an instrument approach chart (fig. 6), although this chart would now include the emergency breakout maneuver required for this procedure. (The emergency breakout maneuver is defined as an emergency escape maneuver (EEM) and is described in the section “Emergency Escape Maneuver.”) Aircraft would either be radar vectored or use a charted route to become established on the final approach course with the flight crews selecting the relevant approach either through the Flight Management System (FMS) or a dedicated navigation radio control panel. Until the aircraft were on the final approach course, they would be separated vertically by a minimum of 1000 ft for the two approach streams. During this time, the airborne components of the AILS system would perform the required electronic handshakes, via data link, between aircraft and announce the availability of the system to perform AILS to the flight crew. (The equipment is

described in section “Hardware Architecture.”) The flight crew would then be cleared for the AILS approach procedure, with a subsequent reduction of vertical separation between the approach streams. Under normal conditions, no other AILS specific actions would be required of the flight crew.

Loss of AILS Capability

The loss of AILS capability could be caused by several factors such as hardware failure, loss of the DGPS signal, loss of data link. The flight crew response to the loss of AILS is dependent on the situation at the time of the loss. Prior to the reduction of vertical separation between the approach streams or the acceptance of the approach from ATC, normal ATC procedures are adequate for separation maintenance. Once the descent on the final approach has started, system or signal failure will activate the climb-turn warning, requiring the flight crew to perform an immediate EEM (described later). In addition, aircraft within a predefined longitudinal distance on the other parallel approach are considered to be “paired” for collision-alerting purposes. Loss of data link with these paired aircraft will also generate a climb-turn warning; again an immediate EEM will be required.

Potential Loss of Lateral Separation

On the rare occasions that one aircraft flies off path and produces a potential collision situation with an aircraft on the other approach, the AILS concept provides a series of alerts for both the intruding aircraft and the nonintruding, evading aircraft. Caution alerts are provided in both aircraft to heighten the crew’s awareness to the developing situation (ref. 3). If the potential collision situation continues, warning alerts are then provided. Again, the AILS warning alert (the climb-turn alert) requires an immediate EEM. Also these alerts are sequenced such that the intruding aircraft is alerted first. The normal sequence for alerts for this rare event would be intruder-caution, evader-caution, intruder-warning, and finally, evader-warning. If the flight crew of the intruder either correct the situation when they receive the caution alert or they perform an EEM on their warning, the warning to the noninterfering aircraft may never occur. This sequencing then penalizes the intruder first (with a climb-turn warning) and reduces the ATC disruption that would be caused by both aircraft executing an EEM.

Emergency Escape Maneuver

AILS is fundamentally a procedures-based concept with conventional Instrument Approach Procedures used as a basis for a “normal” operation. In the rare event that a normal operation does not occur—that is, an aircraft flies off its approach and threatens another—the AILS concept relies on a fixed documented procedure to minimize the collision risk. Based on previous analytical efforts and industry studies (refs. 2, 4 to 9), it was determined that a maneuver in which an aircraft climbed, accelerated, and turned 45° away from the approach path of the other aircraft would provide a simple yet effective means for dealing with a potential collision situation. This maneuver would be part of the published Instrument Approach Procedures (see fig. 6 for an example) and would be performed whenever an AILS collision alert warning is activated. This climb-turn procedure is defined as an EEM. Also note that reference 4 describes the advantages that a climb-turn maneuver has relative to a climb-only maneuver.

Because the occurrence of an EEM is considered to be very infrequent, the cost of implementing autopilot or flight guidance information for the EEM was considered to be prohibitive relative to the benefit. The EEM is procedural and is performed without unique autopilot or flight director guidance.

Hardware Architecture

The AILS concept requires a DGPS (or equivalent) navigation source, an aircraft-to-aircraft data link, AILS alerting logic, and supporting flight crew displays. For the aircraft-to-aircraft data link, the Automatic Dependent Surveillance Broadcast (ADS-B) format (ref. 10), which provides aircraft state data and custom operation’s specific data packets, will satisfactorily provide for all AILS requirements. The current AILS hardware architecture, developed primarily by Honeywell, Inc., places the AILS alerting functions into the Traffic Alert and Collision Avoidance System (TCAS) hardware (fig. 7). Several advantages to this design are first, there needs to be interoperability between TCAS and the AILS alerting; that is, while AILS should provide alerting of the appropriately “paired” aircraft, TCAS alerting should still be available for all other aircraft. Second, by using the standard TCAS visual and audio inputs into the flight deck display equipment, no new aircraft cabling is required for that part of the installation.

Alerting Algorithm Description and Associated Displays

Table 1 provides a summary of the AILS alerts. From this table, it can be seen that the six AILS alerts can actually be depicted as three alert sets, each with two levels of alert states.

Table 1. AILS Alerts and Thresholds

(a) Alerts

Alert state	Alert level	Representation		Description
		Visual ^a	Audio	
Localizer	Advisory	LOCALIZER		Ownship is off centerline by one half path width (traditional one half full-scale error on lateral deviation indicator)
Localizer	Caution	LOCALIZER		Ownship is off centerline by full path width (traditional full-scale error on lateral deviation indicator)
Path	Caution	PATH	Path parallel approach	Ownship performance producing possible collision situation
Path	Warning	CLIMB TURN	Climb turn	Ownship performance producing probable collision situation
Traffic	Caution	TRAFFIC	Traffic parallel approach	Ownship being threatened with possible collision
Traffic	Warning	CLIMB TURN	Climb turn	Ownship being threatened with probable collision

^aVisual alerts are color coded as follows:

Advisory: cyan

Caution: amber

Warning: red

Table 1. Concluded

(b) Collision alert thresholds

Alert state	Alert level	Alert area threshold, ft, for—			Alert time threshold, sec
		Vertical	Lateral	Longitudinal	
Path	Caution	1500	1500	4000	25
Path	Warning	1100	1100	3000	19
Traffic	Caution	1300	1300	3500	22
Traffic	Warning	900	900	2500	16

Localizer Alerts

The LOCALIZER alerts are the simplest of the AILS alerts and only provide an indication of the lateral tracking performance of ownship. A LOCALIZER advisory alert is issued whenever ownship deviates farther than one half the width of the lateral boundary from the approach path centerline. From a piloting standpoint, this is the traditional half-scale needle deflection (or greater) on the Course Deviation Indicator (CDI). For the aircraft configuration used in this test, the alert is presented on the Electronic Attitude Director Indicator (EADI) in the same location as the TCAS messages. An example of this alert is provided in figure 8. A second LOCALIZER alert is issued whenever ownship deviates farther than the full-scale width of the lateral boundary from the approach path centerline. From a piloting standpoint, this is the traditional full-scale needle deflection on the CDI. This localizer caution alert is similar to the LOCALIZER advisory alert, except that it is in amber.

Path Alerts

Although the major safety factor for an AILS operation is based on accurately flying the approach path, most of the AILS technology focuses on the alerting algorithms for the collision risk unique to an AILS operation. This focus is similar to the process used in the Precision Runway Monitor (PRM) development, where the qualities of flight path performance for parallel ILS approach operations are well-known, but the level of safety needed to conduct these operations at reduced runway separations dictate an enhanced collision alerting capability. Therefore, although the localizer alerts described previously only deal with simple off-path performance, the remaining AILS alerts are based solely on the collision risk between actual pairs of aircraft.

The two-level set of AILS “PATH” alerts is designed to aid in avoiding collisions in the event that the ownship maneuvers in a manner that would threaten the adjacent aircraft. For these alerts, the onboard alerting algorithm uses state information from the traffic on the parallel approach, transmitted by ADS-B, to detect situations where the potential path of the ownship may be threatening the adjacent traffic. If this situation occurs, the onboard alerting system generates a PATH caution alert as this situation begins to evolve. This alert is intended to heighten the crew’s awareness of their flight path management and traffic situation. At this time, the crew should be taking action to place their aircraft back on course. As the path performance further degrades and the collision danger becomes more imminent, a PATH warning alert is generated. In this situation, the annunciation of this warning alert requires the flight deck crew to execute an EEM.

The basic intrusion alerting algorithm, referred to as the “segmented alerting algorithm,” is described in reference 9. This algorithm was refined by Langley and Honeywell personnel; intruder alerts were added to the initial design along with several other enhancements. In simple terms, the

PATH collision predictions are time based around a predefined volume centered about the adjacent “protected” aircraft. For the PATH caution alert, a volume defined as ± 1500 ft vertically, ± 1500 ft laterally, and ± 4000 ft longitudinally centered about the adjacent aircraft is used. The protected airspace is elliptical in the horizontal plane and is always centered on the protected aircraft. With state information from each aircraft and the other aircraft assumed to fly its nominal approach profile, both aircraft positions are incrementally estimated along their potential ground tracks for a period of 25 sec, which is defined as the alert threshold time for this alert. If the projected position of ownship falls within the defined volume centered around the projected position of the adjacent aircraft, a PATH caution alert is generated by the AILS system on ownship.

The segmented alerting aspect of this algorithm is based on the generation of a family of projected, potential ground tracks, derived as a function of the turn rate of ownship. The first segment is generated with the assumption that ownship is not turning. Subsequent segments use the actual turn rate of ownship, but vary the time in the turn, up to a time interval equal to the alert threshold time (again, 25 sec for the PATH caution alert). Figure 9 illustrates this concept; in this illustration, ownship is turning to the right. The first segment, portraying the current instantaneous ground track, does not take the turn rate of ownship into account. The rightmost segment assumes that ownship is turning for the entire alert threshold interval. One of these segments will generate a PATH caution alert, where the projected position of ownship will be within the PATH caution alert volume of the adjacent aircraft.

The PATH caution alert is annunciated to the flight crew through both auditory and visual means. A voice alert is provided with the phrase “path parallel approach” spoken twice. Visually, the message “PATH” is presented on the EADI in the color amber (fig. 10(a)). As an enhancement to pilot situation awareness, the ownship symbol on the navigation display (ND) is also color coded amber to highlight the fact that it is the performance of ownship that is causing the alert (fig. 10(b)). Because of the relative closeness of the adjacent aircraft, AILS uses a nonstandard, higher resolution ND map scale. For this implementation, the minimum map scale was 2.5 nmi, whereas traditional convention is typically a minimum of 5 or 10 nmi.

The PATH warning alert, which is for a more critical situation than the PATH caution alert, uses an alert volume defined as ± 1100 ft vertically, ± 1100 ft laterally, and ± 3000 ft longitudinally and an alert time threshold of 19 sec (table 1). The segmented alerting algorithm works in the same manner as described for the PATH caution. This alert is also annunciated to the flight crew through both auditory and visual means. Since an immediate EEM is the correct response to this alert, the voice alert phrase is “climb turn,” spoken twice, and the message “CLIMB TURN” is presented on the EADI in the color red (fig. 11). In addition, the ownship symbol on the ND is also color coded in red.

Traffic Alerts

Like the PATH alert, the AILS “TRAFFIC” alert is also a two-level set that is designed to aid in avoiding collisions in the event that the adjacent aircraft maneuvers in a manner that would threaten ownship. This alert set is obviously the “other side” of the alerting scheme. Again with the state data of ownship and the adjacent aircraft, the onboard alerting algorithm determines if a situation is evolving in which the adjacent aircraft is threatening ownship. If this situation occurs, the onboard alerting system generates a TRAFFIC caution alert. This alert is intended to heighten the crew’s awareness of the traffic situation. No crew action is required for a TRAFFIC caution alert. As the collision danger becomes more imminent, a TRAFFIC warning alert is generated. In this situation, the annunciation of this warning alert requires the flight deck crew to execute an EEM.

The TRAFFIC caution alert uses an alert volume defined as ± 1300 ft vertically, ± 1300 ft laterally, and ± 3500 ft longitudinally and an alert time threshold of 22 sec (table 1(b)). The segmented alerting algorithm described again centers the alert volume about ownship. The significant difference between this and the PATH alert calculations is that the future position of ownship is projected along its approach path while the position of the adjacent aircraft is projected along the family of turn segments (fig. 12). In this regard, the alerting calculations are performed for the other side relative to the PATH alerts.

As with all other potential collision alerts, the TRAFFIC caution alert is annunciated to the flight crew through both auditory and visual means. A voice alert is provided with the phrase “traffic parallel approach” spoken twice. Visually, the message TRAFFIC is presented on the EADI in the color amber (fig. 13(a)). On the ND, the adjacent aircraft is now presented in a manner similar to a TCAS traffic advisory (TA) (fig. 13(b)). This symbology is augmented over basic TCAS in that the ground-track vectors of the traffic is included in the symbol. It should be noted that the ground-track information is provided over the ADS-B data link.

The TRAFFIC warning alert, which is a more critical situation than the TRAFFIC caution alert, uses an alert volume defined as ± 900 ft vertically, ± 900 ft laterally, and ± 2500 ft longitudinally and an alert time threshold of 16 sec (table 1(b)). The segmented alerting algorithm works in the same manner as described for the TRAFFIC caution. This alert is also annunciated to the flight crew through both auditory and visual means. Since an immediate EEM is the correct response to this alert, the voice alert phrase is “climb turn,” spoken twice, and the message “CLIMB TURN” is presented on the EADI in the color red. In addition, the traffic symbology changes to the conventional TCAS resolution advisory (RA) red box for the TRAFFIC warning alert (fig. 14). Implementation details for the traffic and path alerts are provided in reference 11.

Alert Priority and Sequence

The alerting system is designed such that only one of the six alerts can occur at any time and is timed and sequenced to eliminate lower priority and nuisance alerts. For example, a LOCALIZER caution alert would not be issued after a PATH caution alert. All collision alerts have priority over the LOCALIZER alerts. Also from examining the alert threshold times in table 1(b), it can be seen that the intruding aircraft is alerted first to the collision risk. As noted previously, the normal sequence for alerts for this rare event would be intruder-caution, evader-caution, intruder-warning, and finally, evader-warning. This sequencing therefore penalizes the intruder first (with its climb-turn warning) and reduces the ATC disruption that would be caused by both aircraft executing the EEM.

Evaluation Design and Conditions

The focus of this simulation experiment was to evaluate pilot performance, pilot acceptability, and minimum miss-distances for the rare situation where an aircraft on one approach intrudes into the path of an aircraft on the other approach. That is, this test only examined situations where another aircraft flies off-path towards ownship, which activates ownship TRAFFIC alerts.

Previous analytical studies, showing a suitable level of operational safety, were based on the assumptions that pilots would respond to the AILS TRAFFIC warning alerts in a timely and reasonably aggressive manner. The assumptions used for this study, which greatly influenced the selection of the alert threshold times, were a 2-sec pilot delay (pilot reaction time) followed by a roll rate of 4 deg/sec until a roll angle of 30° was obtained. These assumptions, along with the selection of the alert thresholds, were designed to produce a minimum miss-distance of 1200 ft. Therefore, the critical

objective criteria for this test, based on these assumptions, were pilot reaction time and minimum miss-distance.

Test Subjects

The test subjects used in this study were Boeing 757 airline pilots, all with TCAS experience. A total of 18 pilots were used for data collection, with data from 16 of these subjects used in the quantitative analysis. The selection criteria for the data sets are described in the section “Results.”

The subjects participated in a typical two-crew operational scenario, with the second crewmember being a “confederate” of the research team. This crewmember confederate was a qualified transport-category pilot. For this evaluation, the subject’s role was always that of the captain, pilot flying.

Independent Variables

This experiment was designed with three independent variables: intruder geometry, runway separation, and flight control mode. The dependent measures were pilot reaction time and miss-distance in a full factorial test with randomized blocks design. For this study, pilot reaction time is defined as the time interval between the initiation of the TRAFFIC warning alert and the pilot’s initial response to that alert (e.g., autopilot disconnect, application of takeoff go-around power). Miss-distance is defined as the slant-range distance between the aircraft centers of gravity.

In addition to pilot response to an AILS warning alert, the intrusion geometry and aircraft speed differential have an obvious impact on miss-distance for potential near midair collision (NMAC) situations. For this test, the general intrusion geometry selected was chosen for the worst-case situation from the PRM analysis (ref. 1). For this situation, the intruding aircraft banked toward ownship at a moderate rate until a 10° bank angle was obtained. This bank and resulting turn was maintained until a heading change of 30° was obtained. At that time, the intruding aircraft continued at a constant speed along this off-course heading of 30°.

Intruder Geometry and Relative Speeds

A secondary factor for the intrusion geometry is the lateral separation between aircraft at the start of the intrusion event. This lateral separation distance itself was influenced by two factors: lateral runway separation and the lateral offset angles for the approaches. Two runway separations were selected for this test: 2500 ft and 3400 ft. The value 2500 ft was selected as the minimum since this is the current lateral separation minimum due to wake vortex considerations for independent approaches. The value 3400 ft was chosen since this was the minimum value for PRM. In addition, because each approach path was offset 2°, lateral separation was slowly reduced during normal operations as the aircraft approached the runways. To take account of this factor, four different locations were selected along the approach for the initiation of the intrusion event. These locations ranged from outside the final approach fix to an intrusion turn that would generate an ownship alert at decision height.

As in any potential collision situation, large differences in relative speeds tend to increase the collision hazard. For this study, a 30-knot speed difference between the intruder and the ownship was considered to be the maximum difference and was used also as the maximum in the analytical studies. Intruder profiles, therefore, had intruder speeds set at 30 knots faster and 30 knots slower than ownship.

One other variable that was included in the definition of the intrusion geometries was the planned crossing point along the approach path of ownship for the intruder, assuming that the ownship did not maneuver. Five points were used: 2000 ft ahead of ownship, 1000 ft ahead, a direct collision, 1000 ft

behind, and 2000 ft behind ownship. All these points would activate a TRAFFIC warning alert on ownship.

Aircraft Control Modes

The aircraft control mode, manual or autopilot, prior to an AILS warning alert was considered to potentially affect pilot response time. That is, the additional pilot task of disconnecting the autopilot or autothrust system prior to the manual execution of the EEM may increase the assumed pilot delay interval (2 sec) for the EEM. Because of this delay, one of the independent variables of the test design was the control mode prior to the TRAFFIC alert.

Intruder Runway

To maintain a reasonably small scenario set while creating seemingly novel situations for the test subjects, intruder profiles were used for approaches to both left and right runways. The intruder profiles were generated for the right runway scenarios and then mirrored for the left runway.

Pilot Run Matrix

Table 2 is a representative run matrix for a subject pilot. The major blocking factors were control mode and runway separation. Each pilot flew 24 approaches, with 20 of these approaches containing intrusion events. The test matrix itself was designed for 16 subjects; this resulted in a total of 384 approaches. The ordering of the scenarios for each pilot was counterbalanced by these major blocking factors as well as the intruder geometry, which included nonmaneuver miss-distance, intrusion point, and intruder speed differential.

Table 2. Run Matrix for Pilot 1

Run	Control mode	Runway separation, ft	Nonmaneuver miss-distance, ft	Intrusion point	Intruder runway	Intruder speed difference, knots
1	Autopilot	3400	-1000	1	Left	-30
2	Autopilot	3400	0	3	Right	+30
3	Autopilot	3400	1000	4	Left	-30
4	Autopilot	3400	2000	2	Right	+30
5	Autopilot	3400	No intrusion		Left	-30
6	Autopilot	3400	-2000	2	Right	-30
7	Autopilot	2500	-2000	1	Left	+30
8	Autopilot	2500	No intrusion		Right	+30
9	Autopilot	2500	2000	1	Left	-30
10	Autopilot	2500	1000	3	Right	+30
11	Autopilot	2500	-1000	4	Right	+30
12	Autopilot	2500	0	2	Left	-30
13	Manual	3400	No intrusion		Right	-30
14	Manual	3400	1000	1	Right	-30
15	Manual	3400	0	4	Left	+30
16	Manual	3400	-1000	2	Right	-30
17	Manual	3400	-2000	3	Left	-30
18	Manual	3400	2000	3	Left	+30
19	Manual	2500	2000	4	Right	-30
20	Manual	2500	1000	2	Left	+30
21	Manual	2500	-2000	4	Right	+30
22	Manual	2500	No intrusion		Left	+30
23	Manual	2500	0	1	Right	-30
24	Manual	2500	-1000	3	Left	+30

Aircraft Simulator

The aircraft simulator used for this evaluation was the Langley Integration Flight Deck (IFD) facility. This facility is a fixed-based, high-fidelity simulator (fig. 15) configured as the cockpit of the NASA Boeing 757 research airplane and is used primarily to integrate, test, and evaluate new systems and concepts prior to flight test. Both the simulator and aircraft flight deck can replicate a conventional Boeing 757 aircraft, which was the condition for this evaluation. The one significant exception to this standard flight deck layout was the addition of a supplemental ND control panel (fig. 16) which provided optional feature selection and a greater number of map scale selections. For this experiment, map scales to 2.5 nmi, versus the 10 nmi minimum on a standard 757, were provided.

TCAS Integration

The AILS collision alerting algorithms (the PATH and TRAFFIC alerts) were hosted by Honeywell in their TCAS 2000 avionics package. This TCAS unit was itself integrated and hosted in the Langley Research System Integration Laboratory (RSIL). The RSIL is a special purpose laboratory that allows the use of actual avionics flight systems in a simulator environment. As shown in figure 17, the MODE-S/ADS-B, DGPS receiver, and DGPS control panel were all simulated in software. For this study, the IFD simulation provided ownship state data, data from other traffic aircraft (described later), and AILS specific interface control data to the RSIL facility. The RSIL facility processed these data into the proper format (ref. 10) and then placed these data at the appropriate frequency on the ARINC 429 bus for the TCAS. AILS status and AILS alert states were then obtained from the TCAS 429 bus, post-processed, and sent to the IFD simulation. The TCAS analog audio channel was sent directly to the IFD simulator flight deck for output.

Traffic Generation

Traffic data for each of the defined scenarios were electronically generated prior to the simulation study. For each scenario, the initial position of the traffic was based on the initial position of ownship, the nonmaneuver miss-distance, the intrusion point, the speed differential, and the assumption that ownship would fly a nominal approach profile. As noted, the traffic data for the intrusion scenarios were designed such that the intruding aircraft banked toward the approach path of the parallel runway at a moderate rate until a bank angle of 10° was obtained. This bank and resulting turn was maintained until a heading change of 30° was obtained. At that time, the intruding aircraft continued at a constant speed along this off-course heading of 30°.

Because the relative geometry at the time of the ownship TRAFFIC warning alert was critical for the repeatability of the event between each subject, the interpretation and interpolation of these traffic data were synchronized relative to the variability of the speed of ownship such that the relative geometry at the time of the alert would be consistent.

Air Traffic Control Simulation

To add operational realism, an ATC simulation was used during this study. This simulation included a remote ATC station and an audio link with the aircraft simulator. This ATC simulation provided normal approach control and airport tower instructions to the flight crew.

Pilot Training and Evaluation Sequence

The pilot training for this study attempted to represent a typical airline training package for a new flight procedure involving new avionics equipment. This training package (appendices A to C) was structured and scripted to provide for repeatability between the test subjects. The training consisted of a 50-min classroom briefing of the AILS operational concept, a 30-min simulator briefing, and 60 min of simulator training. All training was presented by one of three retired airline captains, who was also used as the first officer, the pilot not flying for the evaluation session (i.e., the confederate pilot). The AILS evaluation session followed the simulator training. The evaluation session took approximately 4 hr to complete.

The classroom briefing (appendix A) provided an overview of the AILS concept and specific training on the operational procedures (appendix B), checklists, equipment, and alerts. The EEM was discussed in detail and was couched as a maneuver similar to the response to a wind shear alert. This briefing also discussed the role of the confederate pilot, first officer, for the evaluation portion of the test. The classroom training concluded with a 5-min written quiz to verify the subject's understanding of the presented material. Deficiencies evident through a less-than-perfect score were rectified before the subject moved on to the simulator training.

Following the classroom briefing, the subject was taken to the IFD simulator for an introduction (appendix C) to the simulator. This introduction was primarily a "differences" briefing; features unique to the IFD, relative to the 757 configuration that the subject normally operated, were explained. This briefing was then followed by the simulator training session.

The simulator training began with the subject pilot flying three approaches. (A detailed description of the simulator training script can be found in appendix C.) The first of these approaches was a normal approach with traffic on the other approach for the parallel runway. The second approach was similar with the exception that a conventional wind shear alert was introduced just as the ownship approached the final approach fix. The subject's response time for this alert was measured to provide a baseline for a secondary research study. The third approach included an intrusion for the other aircraft and a resulting TRAFFIC warning alert. Pilot responses to this alert were used to determine the effectiveness of the classroom training and also to support a secondary research study.

After these three approaches, the confederate pilot, first officer, demonstrated all the AILS alerts. The confederate pilot also demonstrated and provided comments on techniques for an EEM. The remainder of this training period was then used to allow the subject pilot to become familiar with the AILS alerts and practice the EEM.

Initial Conditions

For all the scenarios, both ownship and the parallel approach traffic were started on their respective final approach courses at a distance approximately 14 nmi from their respective runway. One of the two aircraft would already be established on its glide slope, while the other would be within 30 sec of glide slope intercept. The ordering for this variable was counterbalanced in the test design. Because no pertinent situations occurred until both aircraft were well established on their respective glide slopes, this factor was not included in the blocking for the data analysis.

For all the scenarios, both aircraft started at 165 knots (indicated) airspeed (KIAS). For one half of all runs for each pilot, ATC would request a speed reduction to 135 KIAS at the final approach fix. Each subject was briefed that while 165 KIAS is an unusually high speed for a Boeing 757 on final approach,

this higher than normal speed was required to support the conditions of a planned, subsequent flight test of this concept.

Results

Quantitative Results

This experiment was designed with three independent variables: flight control mode, runway separation, and intruder geometry. The dependent measures were pilot reaction time and slant-range miss-distance in a full factorial test with randomized blocks design.

During the data collection portion of this evaluation, several anomalies were noted in the recorded data. Two of the first 16 subjects experienced a large number of simulator problems during the test. Because of this, their test conditions were repeated with the two “spare” test subjects. The quantitative data for these first two subjects were not used, with the test design remaining at 16 subjects. Of the included runs, several other data problems were noted. One run that was designed to be an intrusion scenario was incorrectly programmed such that no intrusion occurred. This run was discarded from the analysis data set. In addition, three intrusion scenarios resulted in pilot reaction times of 0.0 sec. It was determined that this situation could only have been an artifact of the data collection process. These three data runs remained in the data set but were treated as “missing” values.

Table 3 and figure 18 illustrate the overall minimum, average, and maximum miss-distances (measured from each aircraft center of gravity) for the control mode and runway separation configurations. Table 4 and figure 19 provide a similar illustration for pilot reaction times.

Table 3. Slant-Range Miss-Distance

Control mode	Slant-range miss-distance, ft, for runway separation of—		Miss-distance category
	2500 ft	3400 ft	
Autopilot	1418.8	1187.9	Minimum
	2169.1	2248.8	Average
	3262.1	3303.2	Maximum
Manual	1302.1	1187.2	Minimum
	2232.4	2295.1	Average
	3326.3	3613.6	Maximum

Table 4. Pilot Reaction Times

Control mode	Reaction time, sec, for runway separation of—		Reaction time category
	2500 ft	3400 ft	
Autopilot	0.040	0.200	Minimum
	1.124	1.107	Average
	2.680	2.440	Maximum
Manual	0.120	0.160	Minimum
	0.839	0.947	Average
	1.840	1.640	Maximum

As can be seen in tables 3 and 4, the lowest recorded miss-distance was 1187.2 ft, whereas the average reaction times were below 2.0 sec, regardless of the runway separation. A description of the analysis on miss-distance and pilot reaction times is provided in appendix D. A synopsis of this analysis is as follows.

Miss-Distance

Miss-distance was not significantly affected by either runway separation or flight control mode. In addition, the design-goal mean miss-distance of 1200 ft with a 3σ range of ± 500 ft was surpassed. The actual mean miss-distance was 2236 ft with a 95-percent confidence interval of ± 52.645 ft and a standard deviation of 479 ft.

Pilot Reaction Time

Pilot reaction time was not affected by runway separation. A statistically significant effect was noted for the flight control mode, with autopilot use prior to the EEM leading to longer reaction times. It should be noted, however, that with less than a 0.3-sec difference in mean values between the control modes, this difference is probably not operationally significant. An overall average reaction time of 1.11 sec was noted for all conditions, which was well below the design-goal reaction time of 2.0 sec.

Qualitative Results

Subjective data were taken by a questionnaire (appendix E). As previously noted, 18 pilots participated in this test, with data only from 16 of these pilots used in the quantitative analysis. For the qualitative analysis, however, data from all 18 subjects were used. The one exception to this was in the correlation between the quantitative performance data and the subjective responses relating to this performance. In this regard, only the subjective data from the 16 subjects used in the quantitative analysis were included in the correlation of these specific performance questions, for example, flight control mode.

A total of 18 questions were in the questionnaire, 12 were scaled and 6 were free-response questions. The 12 scaled, discrete questions were analyzed by using quantitative analysis methods, and the free-response questions were summarized exactly as written by the subjects. For the scaled questions, the answers were collected on a 5-point interval scale except for questions 9 and 10. The value of 1 was considered to be the extreme negative end of the scale and the value of 5 was considered to be the extreme positive end of the scale. Questions 9 and 10 discussed the flight control mode and were categorical (autopilot, manual, or “doesn’t matter”) and were scaled 1 to 3. To quantify and analyze the free responses, a score of 1 to 5 was assigned to the answers, a value of 1 being an extremely negative comment and 5 being an extremely positive comment.

Scaled, Discrete Questions

The following questions were asked as the scaled, discrete questions on the questionnaire:

1. From a real-world line-operations viewpoint, would AILS be practical (please exclude equipment specific issues such as the displays and alerting system)?
2. Were the operational procedures clear and easy to understand?

3. Was the AILS training adequate?
4. Regarding your safety (collision risk) relative to the other aircraft, the situation was
5. Were the alerts clear and unambiguous (did you know what each alert meant)?
6. When you received an alert (advisory, caution, or warning), did you understand the necessary response?
7. Was the procedure for the emergency escape maneuver (EEM) reasonable?
8. Was the emergency escape maneuver (EEM) easy to perform?
9. Which flight control mode would you use to fly the AILS approach?
10. Was your response to the EEM alert slowed by flying an autopilot approach (that is, the manual takeover to perform the EEM)?
11. Do you think the 2.5-nmi map scale setting was necessary for AILS operations?
12. Did the background ATC communications give you a realistic perception of day-to-day operations?

Responses from the scaled, discrete questions, excluding questions 9 and 10, are provided in table 5. From these results, it can be seen that the general rating was “practical” or “reasonable.” The one exception to this was in regard to performing the EEM, which was rated between “neither reasonable nor unreasonable” and “reasonable.”

Table 5. Summary Statistics for Responses to Questionnaire Questions 1 Through 8, 11, and 12

Question	Number of responses	Mean	Standard deviation	Standard error mean
1	18	4.5	0.616	0.145
2	18	4.7	0.428	0.101
3	17	^a 3.8	0.529	0.128
4	18	4.6	0.502	0.118
5	18	4.9	0.3234	0.0762
6	18	4.9	0.2357	0.0556
7	18	4.1	0.963	0.227
8	17	3.4	0.87	0.211
11	18	4.1	1.132	0.267
12	18	4.9	0.3234	0.0762

^aQuestion rated on a scale of 1 to 4.

The results to the two correlated, scaled questions, questions 9 and 10, relating to flight control mode, are shown in figures 20 and 21, respectively. From figure 21 the subjects appear to incorrectly perceive their reaction time performance relative to the actual performance data for the flight control mode, with the overall rating showing no effect. However, it should again be noted that although the quantitative results did show a statistically significant in performance, there was less than a 0.3-sec difference in mean values between the control modes. This difference is probably not operationally significant nor should it be expected that the subjects could perceive this small difference.

Free-Response Questions

Although the responses to the free-response questions were scored, the primary intent of these questions was to solicit opinions concerning potential areas for improvement. The following questions (questions 13–16 of the pilot questionnaire) were asked in the free-response questions:

13. Please provide your comments on the AILS operational concept.
14. While the AILS concept is not dependent on the specific implementation of the alerts that were presented, it would be useful to know if you had any comments on the alerts.
15. While the AILS concept is not dependent on the specific implementation of the displays that were presented, it would be useful to know if you had any comments on the displays.
16. Please provide your comments on the emergency escape maneuver (EEM).

Because the intent was to identify improvement areas, the following comments are biased toward identifying these improvement areas and exclude most of the “favorable” comments. The pertinent comments are as follows:

1. The visual “TRAFFIC” alert cue is too similar to a TCAS alert.
2. Following an EEM, the EEM “bug” needs to remain on the display until manually deselected.
3. The EEM required a good, aggressive maneuver, which is counter to the “smooth and slow” habits of typical airline flying.
4. The EEM should be evaluated using a maximum of 25° of bank angle.
5. TCAS traffic alerts should be inhibited for a longer period after an EEM. A “nuisance” traffic alert was issued after the EEM.

On the positive side, the comments can generally be summarized by those of one of the subjects: “I came into this study with a bias. I never thought it was a good idea to pack even more traffic into an already crowded system. But now, I’m not so sure. The simulation seemed reasonable, doable and safe.” The consensus from the subjects noted from these questions is as follows:

1. The operational concept is reasonable.
2. The AILS alert sequencing was good.
3. No significant display issues were noted.
4. The aggressive nature of the EEM requires the crew to be mentally prepared to execute it on every approach. The EEM is aggressive without being violent.
5. Autothrottle using the TOGA (takeoff go-around) switch would be beneficial for the EEM.
6. At times, the target on the navigation display could be seen moving towards you, providing an early indication of a problem.
7. The EEM training will be important.

Scoring results for the responses to the free form questions are provided in table 6. From these results, the general ratings were all biased toward the positive or favorable, again noting that a score of 1 to 5 was assigned to the answers, a value of 1 being an extremely negative comment and 5 being an extremely positive comment.

Table 6. Summary Statistics for Responses to Questions 13–16

Question	Number of responses	Mean	Standard deviation	Standard error mean
13	18	4.3	1.018	0.24
14	18	3.3	1.074	0.25
15	18	3.4	1.114	0.27
16	18	2.9	1.022	0.24

Summary of Results

The Airborne Information for Lateral Spacing (AILS) concept is designed to support independent parallel approach operations to runways spaced as close as 2500 ft. This report describes the AILS operational concept and the results of a ground-based flight simulation experiment of one implementation of this concept. The focus of this simulation experiment was to evaluate pilot performance, pilot acceptability, and minimum miss-distances for the rare situation that an aircraft on one approach intrudes into the path of an aircraft on the other approach. From this simulation, the following results were obtained:

1. From an operational standpoint, the concept is reasonable.
2. The measured mean miss-distance was higher (better) than the design-goal mean miss-distance range of 1200 ft with a 3σ of ± 500 ft.
3. The actual mean miss-distance was 2236 ft with a 95-percent confidence interval of ± 52.645 ft and a standard deviation of 479 ft.
4. Miss-distance was not significantly affected by either runway separation or flight control mode.
5. Pilot reaction time was not affected by runway separation.
6. An overall mean reaction time of 1.11 sec was noted for all conditions, which was well below the design-goal reaction time of 2.0 sec.
7. A statistically significant effect was noted for the flight control mode, with autopilot use prior to the emergency escape maneuver (EEM) leading to longer reaction times. However, with less than a 0.3-sec difference in mean values between the control modes, this difference is probably not operationally significant.
8. The AILS alert sequencing was good.
9. No significant display issues were noted in the pilot commentary.

10. The aggressive nature of the EEM requires the crew to be prepared to execute it on every approach.
11. The EEM is aggressive without being violent.

From these results, it can be concluded that this operational concept, with supporting technology and procedures, may provide an operationally viable means for conducting simultaneous, independent instrument approaches to runways spaced as close as 2500 ft.

References

1. *Precision Runway Monitor Demonstration Report*. DOT/FAA/RD-91/5, Feb. 1991.
2. Waller, Marvin C.; and Scanlon, Charles H.: *A Simulation Study of Instrument Meteorological Condition Approaches to Dual Parallel Runways Spaced 3400 and 2500 Feet Apart Using Flight-Deck-Centered Technology*. NASA/TM-1999-208743, 1999.
3. *Flight Deck Alerting System (FAS)*. ARP4102/4, SAE, July 1988 (Reaffirmed May 1994).
4. Winder, Lee F.; and Kuchar, James K.: Evaluation of Vertical Collision Avoidance Maneuvers for Parallel Approach. AIAA-98-4242, Aug. 1998.
5. Kuchar, James K.; and Carpenter, Brenda D.: Airborne Collision Alerting Logic for Closely Spaced Parallel Approach. *Air Traffic Control Q.*, vol. 5, no. 2, 1997, pp. 111–127.
6. Carpenter, Brenda D.; and Kuchar, James K.: *A Probability-Base Alerting Logic for Aircraft on Parallel Approach*. NASA CR-201685, 1997.
7. Carpenter, Brenda D.; and Kuchar, James K.: Probability-Based Collision Alerting Logic for Closely-Spaced Parallel Approach. AIAA-97-0222, Jan. 1997.
8. Pritchett, A.; Carpenter, B.; Asari, K.; Kuchar, J.; and Hansman, R. J.: Issues in Airborne Systems for Closely-Spaced Parallel Runway Operations. *Fourteenth Digital Avionics Systems Conference*, AIAA/IEEE, Nov. 1995, pp. 140–145.
9. Koczo, Steve: *Coordinated Parallel Runway Approaches*. NASA CR-201611, 1996.
10. *Minimum Aviation System Performance Standards for Automatic Dependent Surveillance Broadcast (ADS-B)*. Doc. No. RTCA/DO-242, RTCA, Feb. 1998.
11. Samanant, Paul; and Jackson, Mike: *Description of the AILS Alerting Algorithm*. NASA/CR-2000-210109, 2000.

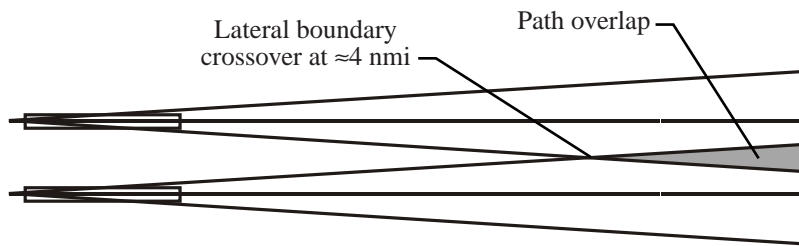

Figure 1. Parallel ILS approaches to runways spaced 2500 ft apart. Drawing not to scale.

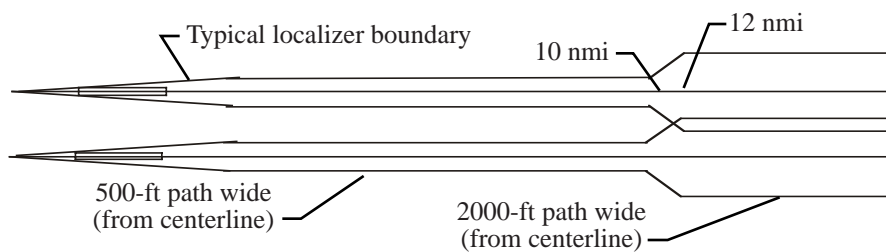

Figure 2. Example of constant-width approach design to two closely spaced parallel runways. Drawing not to scale.

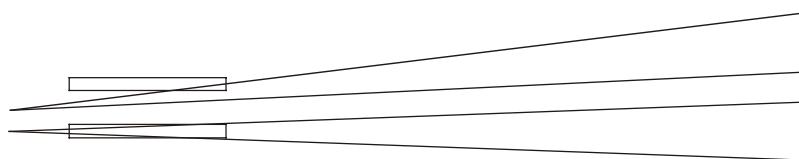

Figure 3. Example of nonoverlapping, ILS-lookalike approaches using single 4° offset.

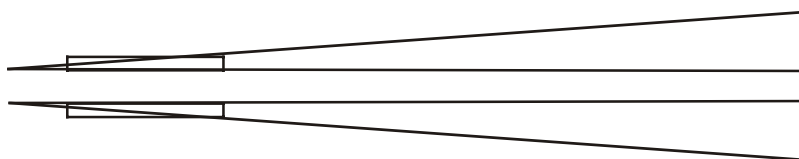

Figure 4. Example of nonoverlapping, ILS-lookalike approaches using dual 2° offsets.

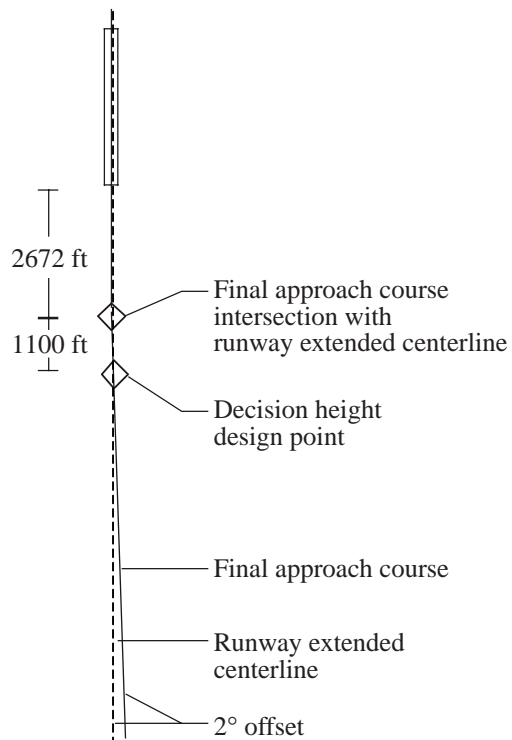
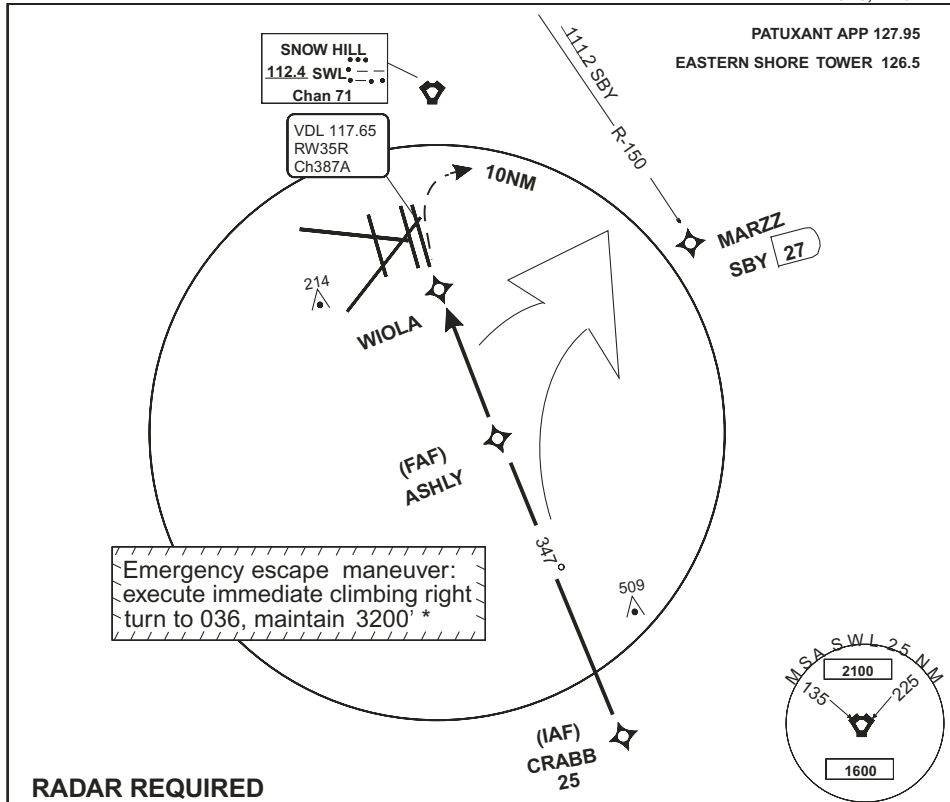

Figure 5. Example of 2° offset approach to right parallel runway (offset is to right side).

AILS GLS RWY 35R

EASTERN SHORE INTL (ETS)
WALLOPS, VIRGINIA



Emergency escape maneuver:
execute immediate climbing right
turn to 036, maintain 3200' *

RADAR REQUIRED

MISSED APPROACH

Climbing RIGHT turn to 3200
via direct MARZZ.

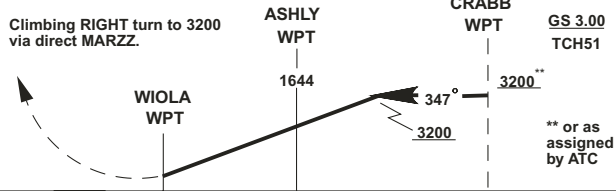

CATEGORY	A	B	C	D
S-35R	291 / 1/2	250 (300-1/2)		
CIRCLING	NA			

The FAC is offset 2° from the runway track; visual navigation shall be used beyond decision height.

Simultaneous Parallel Approaches authorized with Rwy 35L - 3400' between the centerline of runways 35L and 35R.

* If communications have not been established with ATC upon reaching 3200 ft., proceed direct MARZZ.

ELEV 41

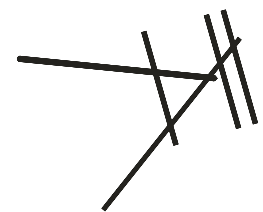

AILS GLS RWY 35R

EASTERN SHORE INTL (ETS)
WALLOPS, VIRGINIA

Figure 6. Example of AILS instrument approach chart.

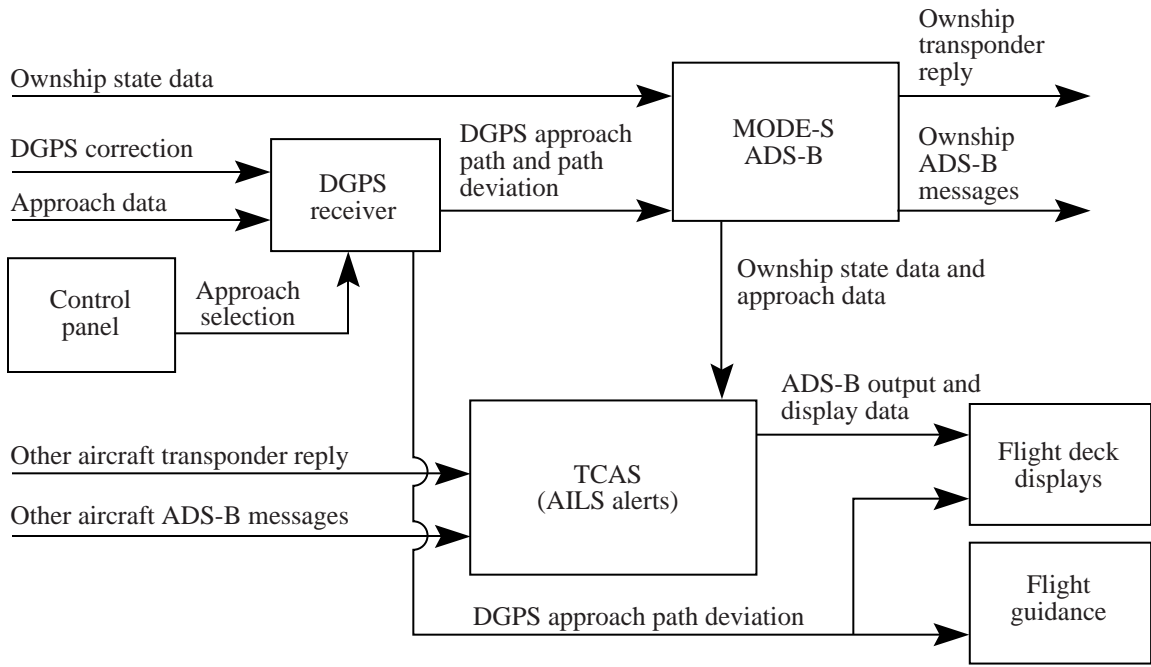

Figure 7. Candidate hardware architecture.

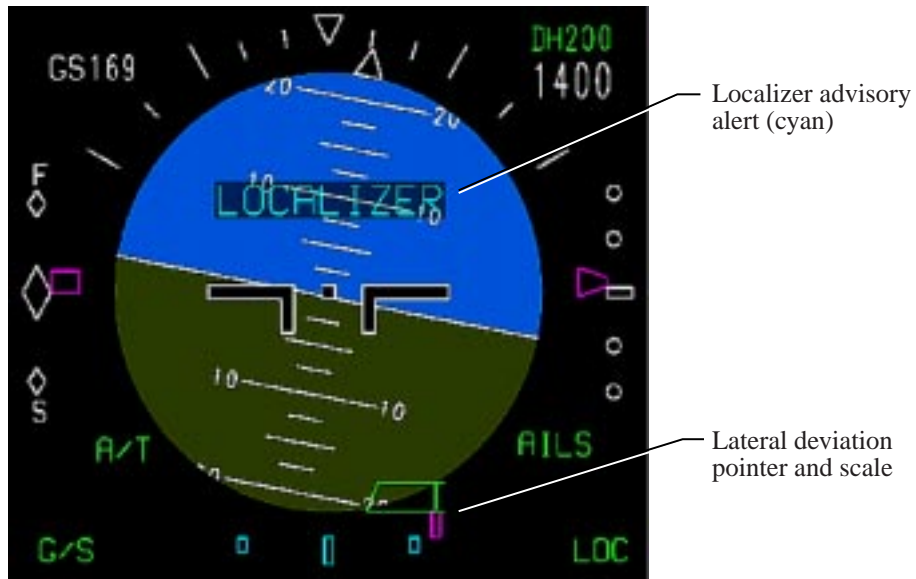

Figure 8. Example of localizer advisory alert.

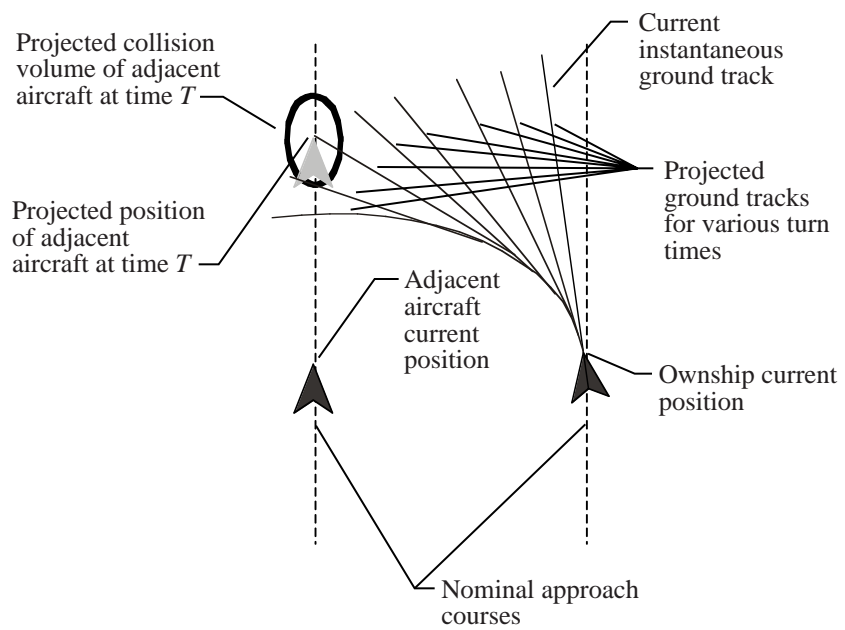
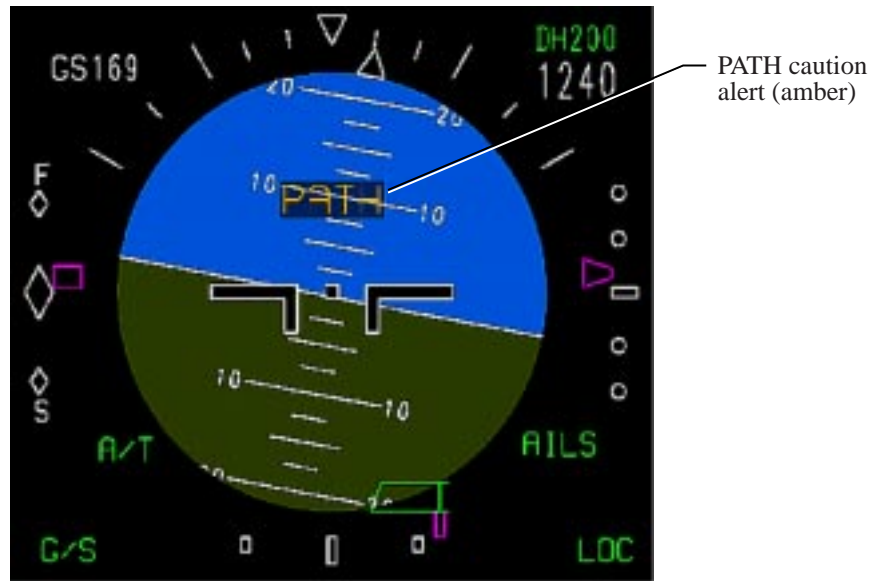
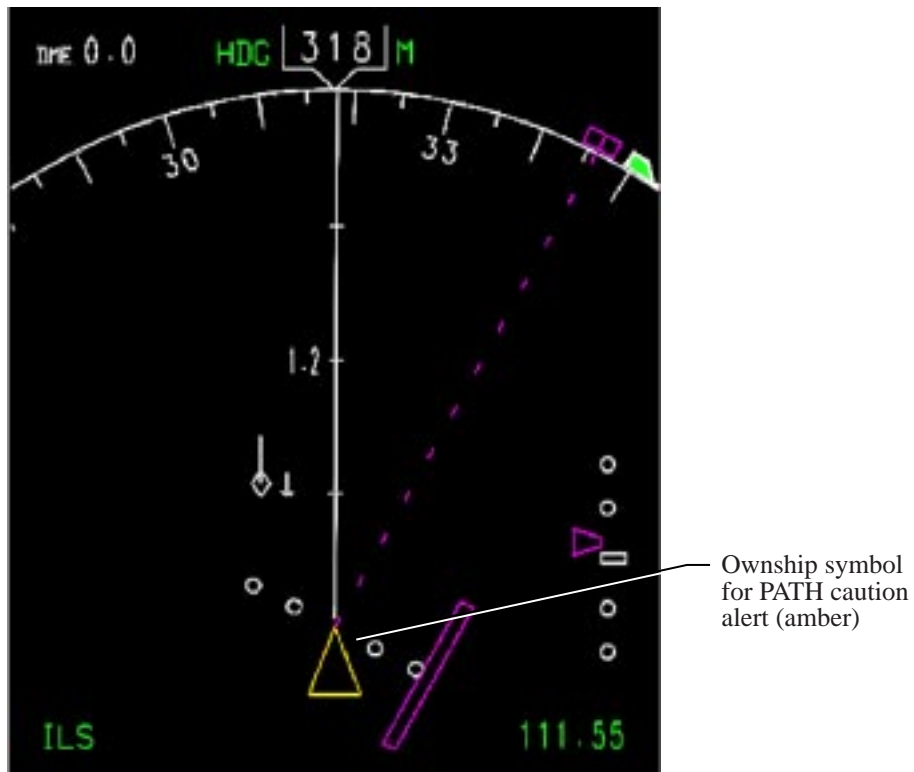

Figure 9. Determining at-fault collision potential of ownship.



(a) EADI example of PATH caution.



(b) ND example of PATH caution alert.

Figure 10. Example of PATH caution alert on EADI and ND.

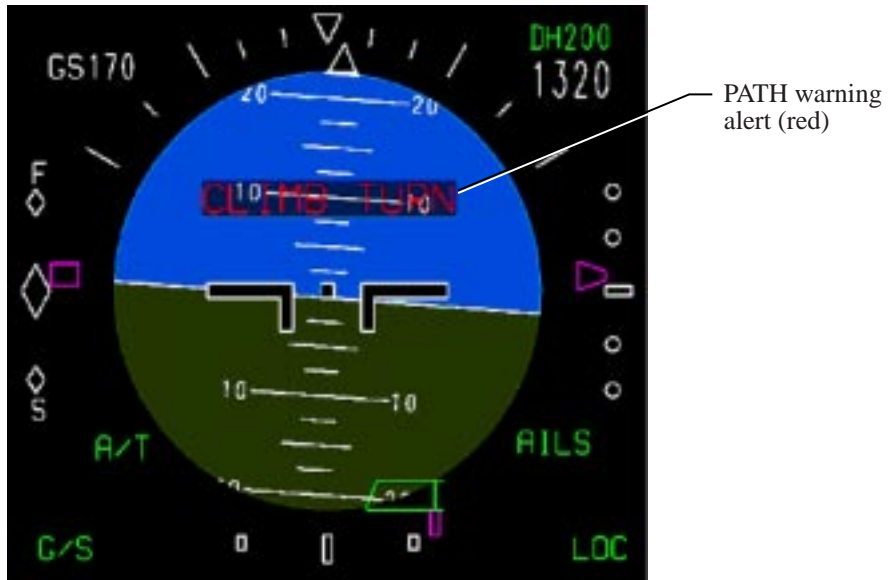

Figure 11. Example of PATH warning alert on EADI.

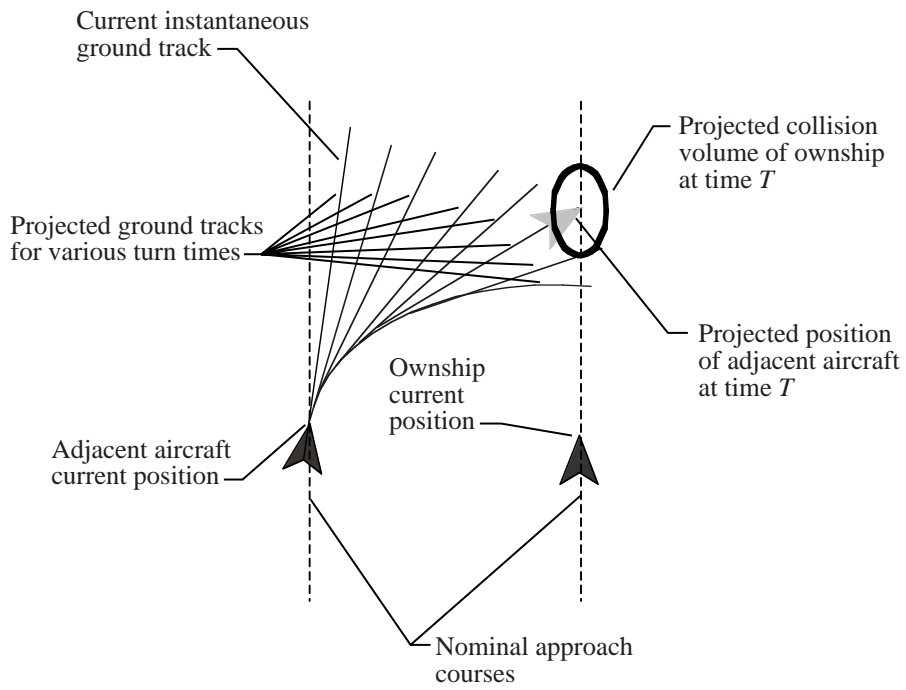
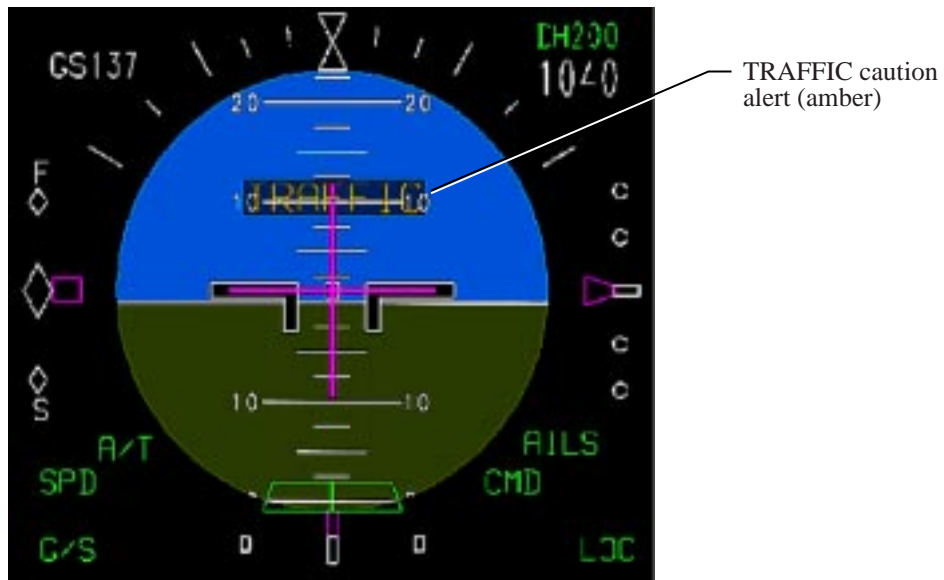
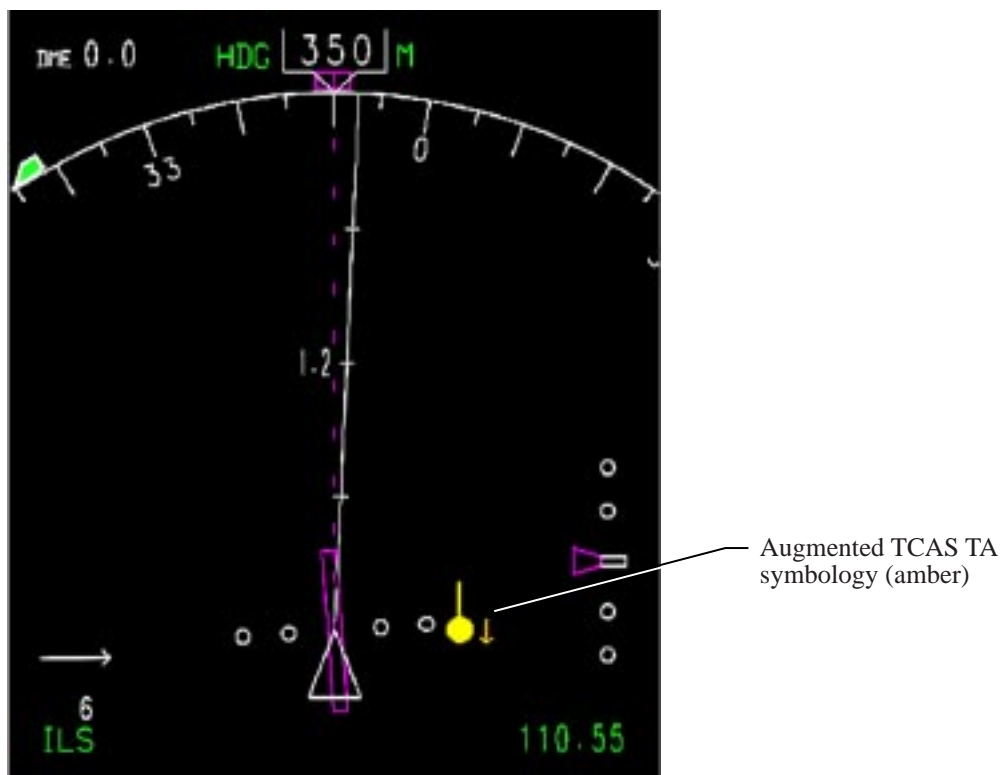

Figure 12. Determining the intrusion threat.



(a) EADI example of TRAFFIC caution alert.



(b) ND example of TRAFFIC caution alert.

Figure 13. Example of TRAFFIC caution alert on EADI and ND.

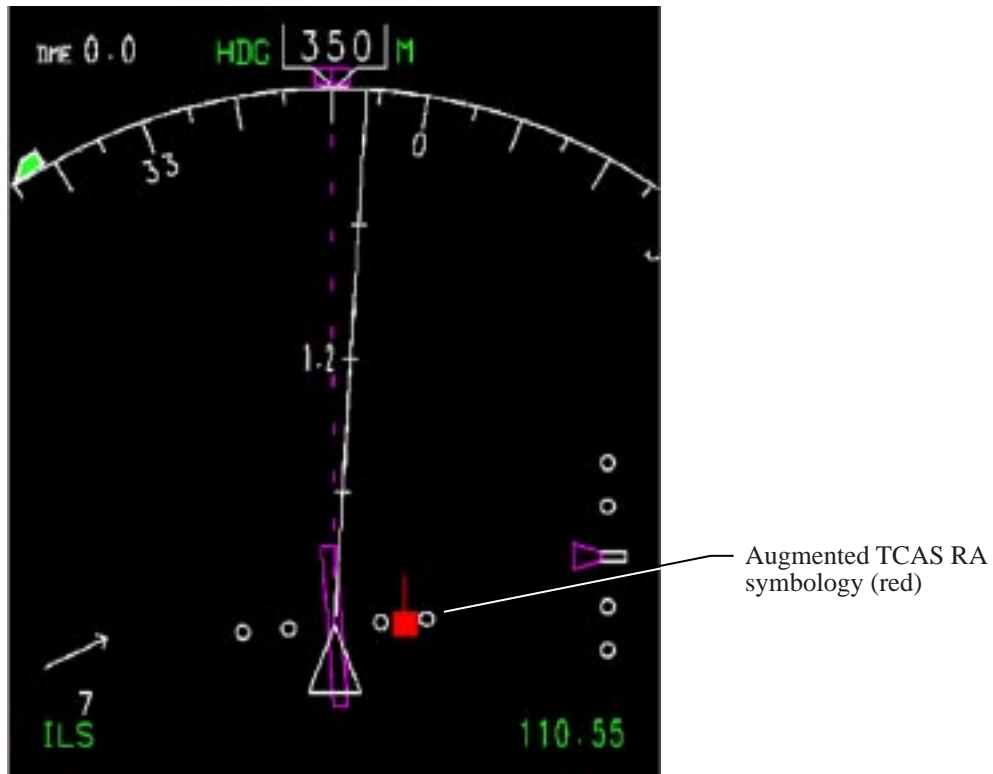

Figure 14. Example of TRAFFIC warning alert on ND.

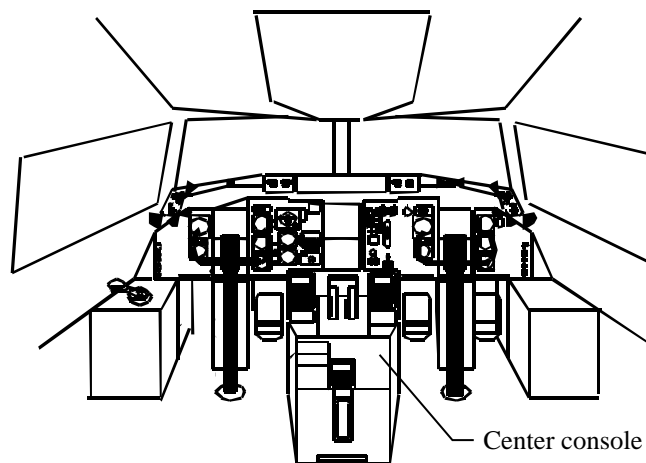

Figure 15. Langley Integration Flight Deck layout.

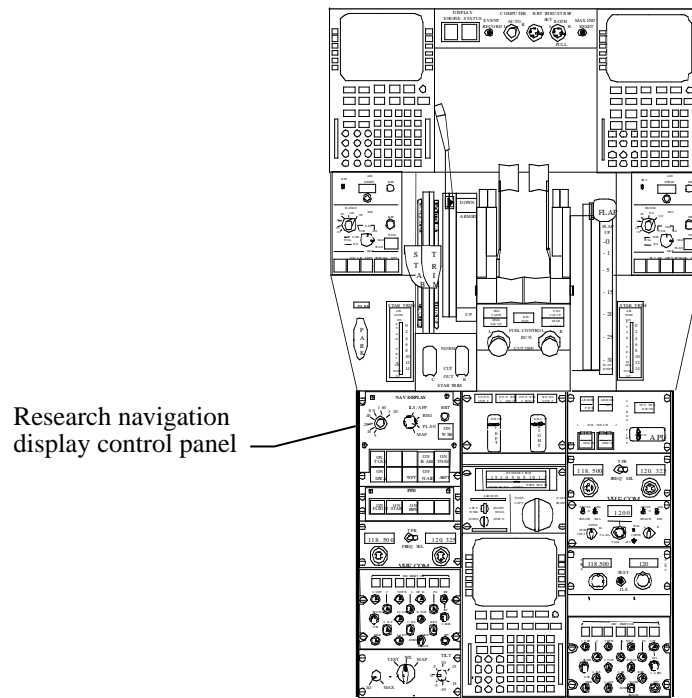

Figure 16. Center console layout.

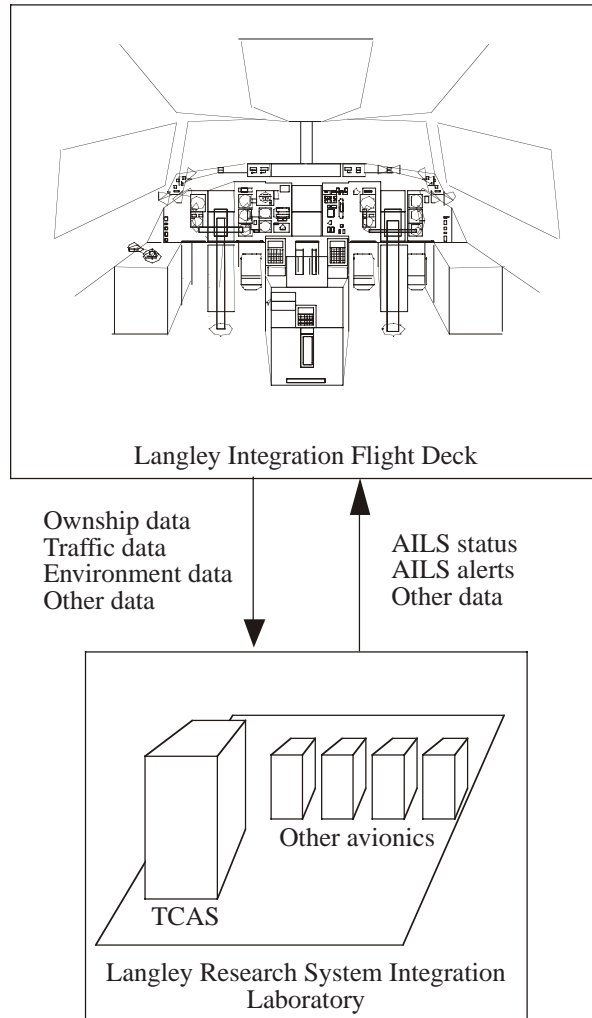

Figure 17. Langley Integration Flight Deck Simulation and Langley Research System Integration Laboratory layout.

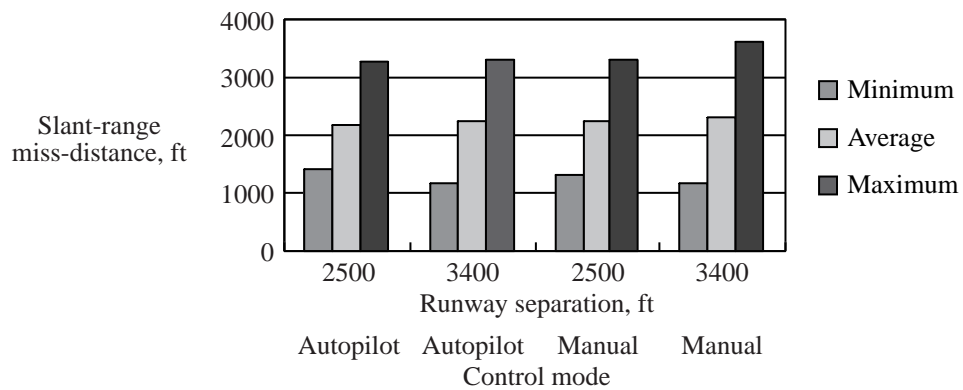

Figure 18. Slant-range miss-distance.

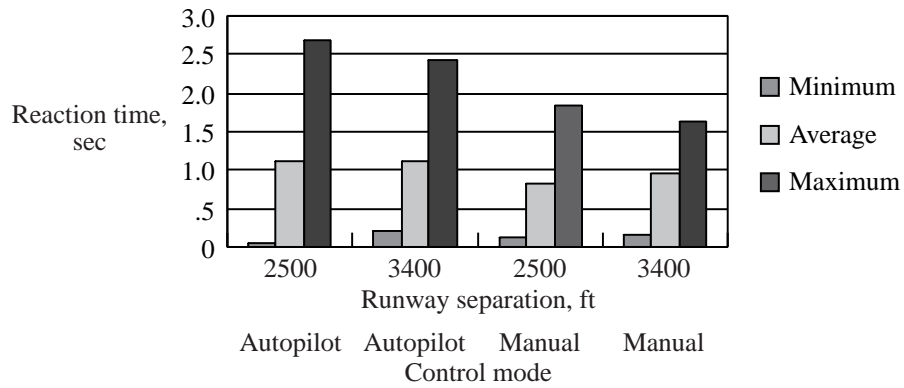

Figure 19. Pilot reaction time.

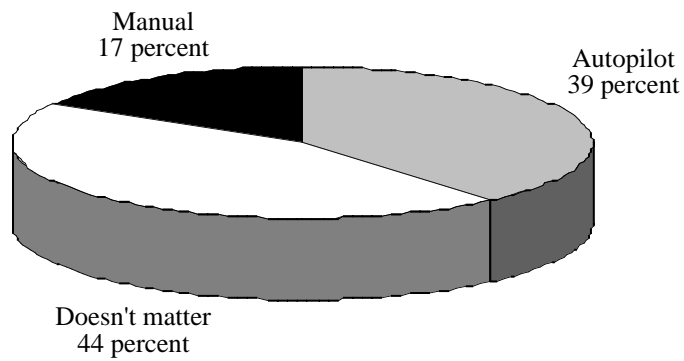

Figure 20. Distribution of responses to question 9.

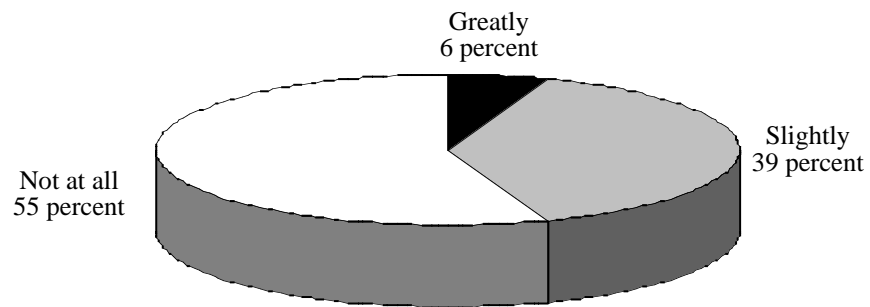

Figure 21. Distribution of responses to question 10.

Appendix A

Classroom Briefing

1.0 Introduction of Instructor

Good morning, my name is _____, and I will be your instructor and copilot for the next two days. Before going into the details of the experiment, let me give you a brief summary of my flying experience: [Provide background here, 1 minute].

2.0 Purpose & Scope of Experiment

AILS is an acronym that stands for Airborne Information for Lateral Spacing. Our mission for the next two days will be to fly a number of closely spaced AILS approaches in a typical airline environment.

3.0 AILS Concept

The AILS system enables aircraft to conduct closely spaced parallel approaches under instrument conditions with a level of safety equivalent to that of closely spaced parallel approaches conducted under visual conditions. Differential GPS position, data link, and computer projections of position are utilized to provide timely information that enables the flight crews to keep each aircraft in its assigned airspace or to make an evasive maneuver, should that become necessary.

If an aircraft deviates from its assigned airspace in today's ATC system, considerable time is required for the controller to detect the deviation, to issue appropriate instructions to the pilot, and for the pilot to correct the flight path of the aircraft. By utilizing data link and computer projections, the time required for an aircraft to respond is reduced significantly.

The probability that a pilot will ever need to make an evasive maneuver is very unlikely. It is estimated that an evasive maneuver will occur only once in every ten million approaches. This is equivalent to one evasive maneuver in the careers of over 500 pilots.

AILS uses part of the TCAS system to data link the positions of each aircraft to the adjacent parallel aircraft. The system is designed so that either TCAS or AILS will be operational whenever the aircraft is above 200 feet AGL. When AILS becomes active, TCAS alerts are replaced with AILS alerts for the adjacent parallel aircraft. You can verify this mode change by the presence of the AILS symbol on the EADI or the EEM bug on the HSI. The TCAS system, however, remains operational for aircraft other than the adjacent parallel aircraft. If the AILS system fails for any reason, both aircraft will receive a "CLIMB TURN" warning at a predetermined distance and time.

ADS-B provides ground track information. This information can be seen as a vector displayed above the TCAS diamond.

4.0 AILS Background

The term "closely spaced" means runway separations less than 4,300 feet, which is the normal minimum for independent IFR operations. The FAA has approved a reduction to 3,400 feet centerline

separation at some airports if special ATC monitoring equipment is installed. The system is called Precision Runway Monitor (PRM) and has been installed at Minneapolis/St. Paul airport.

Previous AILS experiments have explored the pilots' reaction times, their ability to maintain an accurate flight path, the capability of separation algorithms, the suitability of different instrument displays and various runway centerline separations.

5.0 AILS Geometry & Approach Minimums

To ensure that the AILS approaches do not overlap and that minimum separation is maintained, the localizer for each approach is offset by two degrees. The minimums for this approach are 250 feet and 1/2 mile visibility. It should be noted that the dual, two degree offset is just one of several ways to configure the approach geometry for this type of operation.

6.0 AILS Safety Design

As previously stated, AILS approaches have been designed to provide a level of safety that is at least equivalent to VFR operations with 4300 feet runway separation. Many of us feel that the level of safety is greater than the current system. The safety features include the following:

- 1000-foot altitude separation prior to the beginning of the AILS approach.
- 2 degree offset approaches to ensure horizontal separation.
- Differential GPS accuracy.
- Automatic computerized detection of intruding aircraft—even when they are behind you.
- Advisory, Caution and Warning alerts that are designed to keep each aircraft in its assigned airspace.
- A Cautionary and a Warning alert that will advise you of any impending near mid-air collision (NMAC).
- An Emergency Escape Maneuver that is designed to prevent near mid-air collisions, even if the previous alerts have not been effective.

7.0 AILS Alerts

Now let's look at each of the alerts. Assume that AILS is active. You will be able to tell that it is by the presence of a green AILS on the EADI (PFD) and a green EEM bug on the HSI (ND). Also, assume that the other aircraft turns toward your aircraft and does not respond to any visual or aural alert. The resultant alerts are summarized in these tables:

ALERTS IN COCKPIT OF AIRCRAFT THAT IS DEVIATING FROM COURSE

(Assumes other aircraft is on course)

Basis for Alert	Parameter	Alert Level	Display		Pilot Response
			Visual	Audio	
Course deviation	1 dot LOC	Advisory	LOCALIZER		Return to Course
Course deviation	2 dots LOC	Caution	LOCALIZER		Expediently Return to Course
Potential threat to other aircraft	Projected path	Caution	PATH	PARALLEL APPROACH, PATH	Immediately Return to Course
Imminent threat to other aircraft	Projected path	Warning	flashing CLIMB TURN	CLIMB TURN	Execute EEM

ALERTS IN COCKPIT OF AIRCRAFT THAT IS BEING THREATENED

(Assumes threatened aircraft is on course)

Basis for Alert	Parameter	Alert Level	Display		Pilot Response
			Visual	Audio	
Potential threat from intruder	Projected path of intruder	Caution	TRAFFIC	TRAFFIC, PARALLEL APPROACH	Crew awareness, Review Procedure
Imminent threat from intruder	Projected path of intruder	Warning	flashing CLIMB TURN	CLIMB TURN	Execute EEM

- The other aircraft would receive a cyan “LOCALIZER” advisory message on the EADI (PFD) when that aircraft is 1 dot off course. There is no aural information given with this alert. The EADI (PFD) and the HSI (ND) would look like this.
- The other aircraft would receive an amber “LOCALIZER” cautionary alert on the EADI (PFD) when the aircraft is 2 dots off course. There is no aural information presented with this alert. This alert would look like this. Notice that the localizer deviation scale on the EADI (PFD) and the aircraft symbol on the HSI would change to amber.
- The other aircraft would receive an amber “PATH” cautionary alert on the EADI (PFD) if the other aircraft’s path becomes a potential threat to your aircraft. This alert includes an aural “PARALLEL APPROACH PATH.” This situation would look like this. Notice that the aircraft symbol on the ND is still amber.
- The other aircraft would receive a red flashing “CLIMB TURN” warning when the threat reaches a predetermined time and distance threshold. The warning includes an aural “CLIMB TURN” command. This situation would appear like this on the EADI and the HSI. Note that the “CLIMB TURN” and the aircraft symbol are now red in color.

Each of the above alerts, of course, should have caused the other aircraft to return to its assigned airspace. If the other aircraft does not respond to these alerts you will receive the following two alerts.

- If the other aircraft continues to be a threat to your aircraft you will receive an amber “TRAFFIC” cautionary alert on the EADI (PFD) at a predetermined time and distance threshold. This alert is accompanied by an aural “TRAFFIC PARALLEL APPROACH.” The alert would look like this on the

EADI (PFD) and the ND. Notice that the TCAS symbol on the HSI has changed to an amber filled circle.

- If the other aircraft continues to be a threat to your aircraft you will receive a flashing red “CLIMB TURN” warning on the EADI (PFD) at a predetermined time and distance threshold. This alert is accompanied by an aural “CLIMB TURN” command. The situation would look like this. Note that the intruding aircraft is now shown as a red filled square.

It is important to recognize that either aircraft could receive any of the six alerts. For example, you could get the first four alerts if you deviated from your assigned airspace and the other aircraft could receive the last two alerts. You should, therefore, be prepared for any of the alerts and know exactly what you will do if you receive any of these alerts:

- If you receive a one dot “LOCALIZER” alert, you should return to the center of the localizer.
- If you receive a two dot “LOCALIZER” alert, you should expeditiously return to the center of the localizer.
- If you receive a “PATH” alert, you should immediately and aggressively return to your assigned airspace. You should recognize that failure to do so may cause either or both aircraft to make an Emergency Escape Maneuver. You should also ensure that your hands and feet are in position on the controls and quickly review the steps you will take in case you receive a “CLIMB TURN” alert.
- If you receive a “TRAFFIC” alert, you should assume that a near midair collision is imminent and you should ensure that your hands and feet are in position on the controls and quickly review the steps you plan to take if you receive a “CLIMB TURN” alert. Your performance during the Emergency Escape Maneuver will be improved if you mentally rehearse the steps in the Emergency Escape Maneuver just as you would for a rejected takeoff or a missed approach procedure.
- If you receive a flashing red “CLIMB TURN” warning you should immediately follow the steps of the Emergency Escape Maneuver.

We will now discuss the details of the Emergency Escape Maneuver.

8.0 Emergency Escape Maneuver

As previously discussed, the probability of an Emergency Escape Maneuver is very low. If it is ever needed, however, it must be accomplished quickly and precisely. The receipt of a “**CLIMB TURN**” warning indicates imminent danger of a midair collision. This emergency must be considered with the same concern and seriousness as a runway limited rejected takeoff (RTO), an engine fire or an emergency depressurization. The following are the correct steps:

Upon receipt of a “CLIMB TURN” Warning you should immediately and simultaneously

- Disconnect the auto-throttle, if engaged, and select go-around thrust.
- Disconnect the autopilot, if engaged, and increase pitch toward an initial pitch attitude of 15 degrees. The rate of rotation should be approximately 3 degrees per second.
- As the rotation is initiated, aggressively roll into a coordinated 30 degree bank turn away from parallel traffic. The roll rate should be approximately 5–10 degrees per second. A coordinated turn will require about 25% of rudder input.

- Callout, “Go-around thrust; flaps 20”; after observing a positive climb, callout “Positive climb, gear up.”
- Target airspeed for EEM is
 - Low Speed: 145 knots—which is VREF30 plus 15 knots—High Speed: 165 knots—the same as approach speed
- I will inform ATC that you are executing an Emergency Escape Maneuver.
- Continue the climb and turn until the Emergency Escape Maneuver altitude and the heading have been achieved. I will inform ATC when you have reached the EEM heading and altitude.

The Emergency Escape Maneuver is different from and should not be confused with a normal go-around. Care must be taken not to follow the flight director or the approach raw data since they will still be referenced to the normal approach. I will turn off your flight director if you ask me.

9.0 Other AILS Procedures

The following additional procedures apply to AILS approaches:

- A special AILS briefing will be conducted by the PF prior to entering the AILS portion of the approach. This briefing will include the AILS landing runway, the direction of the emergency escape turn, and the EEM altitude and heading. A sample briefing is the following:

“This will be an AILS approach to runway 35R. In the event of an Emergency Escape Maneuver, I will make a climbing right turn to a heading of 036 degrees and will climb to 3200 feet.”

- The PF will announce when the green AILS heading bug and the green “AILS” on the EADI (PFD) are in view. These symbols will remain on the display throughout the AILS approach. Either of these is an indication to you that (1) the normal TCAS RA and TA alerts are inhibited for the other aircraft, (2) the AILS alerts are operational, (3) your aircraft has entered the area of reduced lateral and vertical separation from adjacent traffic, (4) strict compliance with the flight path is required and (5) compliance with warning and caution alerts is mandatory.
- Some airlines require their pilots to keep their hands and feet on the controls during autocoupled approaches to loosely guard the controls and throttles. You should follow your own company’s training in this respect. Whenever you receive a “path” or “traffic” alert, however, you must ensure that your hands and feet are on the controls and that you are prepared to disconnect the autothrottle and autopilot and follow the EEM procedure if you should receive a “CLIMB TURN” warning.

10.0 AILS Matrix

In addition to the training runs, you will fly a number of different approaches during this experiment. The runs will be composed of

- Two runway separations of 3400 feet and 2500 feet.
- Two control modes—Manual and Auto-coupled.

- Two approach speeds: 135 and 165 knots.
- Several different scenarios.

Half of the approaches will be flown at 3400 feet runway separation while the other half will be at 2500 feet. Similarly, half of the approaches will be flown with the autopilot on and half will be flown in the manual mode. **All Emergency Escape Maneuvers will be flown in the manual mode, however.** Some of the approaches will have an intrusion requiring an Emergency Escape Maneuver—some will not. Intrusions may occur at any point in the approach and the intruder may be faster or slower, above or below, or left or right of your aircraft. I will inform you of the Autoflight mode, approach runway and other pertinent information before each run.

11.0 AILS Call Outs

I will make the following normal callouts during all AILS runs:

- Glide slope alive
- Glide slope intercept point
- 1000 feet
- 500 feet
- Approaching minimums
- Minimums

You should respond in accordance with your own airline’s procedures.

In the event of an EEM, I will inform ATC of the following:

- Initiation of Emergency Escape Maneuver (EEM)
- Reaching EEM heading and altitude

12.0 Experimental Limitations of Crew Concept

Normal airline operations use the “crew concept” whereby all members of the crew participate in the operation. Since this experiment will measure your ability to successfully fly AILS approaches, it is necessary to restrict the input of the first officer as follows:

- I will not be able to help you with any part of the data runs that could interfere with the AILS experiment. I will, however, remind you of items you may have forgotten if they do not affect the experiment results.
- I will not point out any course deviations by either aircraft during data runs. You should get this information from your flight instruments and the AILS alerts.
- I will not repeat or reinforce any of the alerts during data runs.

- I will not comment on your Emergency Escape Maneuver technique.
- I will not, however, mislead you. If you ask me a question and I cannot comment because of experimental constraints, I will simply reply, “No comment”.

13.0 General Information

The following is some general information about the experiment:

13.1 Simulator

The approaches will be accomplished in the Langley Integrated Flight Deck (IFD) simulator. The configuration and performance are similar to a Boeing 757 aircraft—approximating that of the NASA Boeing 757-200 research aircraft.

13.2 Type of Operation

All approaches will simulate normal passenger flights with passengers, flight attendants, and a flight deck crew of two pilots.

13.3 Pilot Flying

You will be the pilot flying for all data runs. I will be the pilot not flying. Half of the runs will be flown with the Autopilot; the other half will be flown manually. All emergency escape maneuvers will be accomplished in the manual mode. Autothrottles will not be available in the manual mode.

13.4 Omitted Systems

All airplane systems are considered to be operational. ACARS and its printer are not installed.

13.5 Maintenance Items

There are no deferred maintenance items.

13.6 ATC

We will be using Langley’s ATC facility. It is staffed with a qualified Air Traffic Controller. Parallel traffic will be on a different approach control frequency. Both aircraft will use the same tower frequency.

13.7 Initialization Point

To conserve time, all approaches will begin on the final approach course, 14 NM from the runway threshold. The initial conditions will be

- On localizer with the glide slope armed.
- Altitude of 3,200 or 4,200 feet.

- Autopilot and the speed mode of the autothrottle system will be engaged for autocoupled scenarios.
- Gross weight: 192,000 pounds.
- Gear up.
- Flaps 20 with speed 165 knots.

13.8 Completion of Run

The simulator is not equipped with a visual system. Each approach will be completed at the Missed Approach Point (MAP) or upon the completion of the Emergency Escape Maneuver. I will say “reset” when the run is complete.

14.0 Specific Pilot Flying Responsibilities

- For all approaches, you should follow the flight director to minimums, even if there is an amber Caution alert. At minimums, execute a normal missed approach procedure. In the event of a red Warning (CLIMB TURN) you should immediately execute the Emergency Escape Maneuver.
- Normal SOP dictates that when the Autopilot is engaged, you should control all functions of the Mode Control Panel except for the Altitude Selector. Altitude will be set by the PNF. When the Autopilot is not engaged, the PNF will set everything on the MCP on your command.
- You should adjust the HSI mode and the range on the map as appropriate for the situation. As an initial guide, you can use the ILS/APP mode and the 5 NM RANGE. You may want to select the 2.5 NM range as the parallel traffic gets closer. The lowest range available is 2.5 NM RANGE.
- You will be expected to make all decisions regarding flight path including speed, lateral, and vertical control. I will not touch the control column or the throttles except to reduce thrust to maximum continuous thrust if it is exceeded.
- You will be expected to manage normal items associated with the approach including configuring the aircraft and controlling the flight path. You may ask me to accomplish any item except lateral and vertical control of the flight path.
- After your escape bug is visible, you should brief me about the escape direction of turn, escape heading, and escape altitude. I will inform you if I hear any mistakes.
- On autocoupled approaches, comply with your company’s training regarding position of hands and feet on/near controls. In the event of a “PATH” or “TRAFFIC” alert you must quickly place your hands and feet on the controls and be ready to disconnect the autothrottle and autopilot.
- In the event of a “PATH” or “TRAFFIC” alert, you should quickly rehearse the specific steps of the Emergency Escape Maneuver in case a “CLIMB TURN” warning occurs.

- If an Emergency Escape Maneuver is commanded you should immediately and simultaneously
 1. Disconnect the Autothrottle and set go-around thrust.
 2. Disconnect the Autopilot and initiate a climbing banked turn away from adjacent parallel approach traffic. Use a rotation rate of approximately 3 degrees per second to an initial target pitch attitude of 15 degrees. Use an aggressive roll rate of approximately 5–10 degrees per second to the target bank angle of 30 degrees.
 3. Call “Go-around thrust, Flaps 20” and then “Positive climb, gear up” as you see an indication of a positive climb.
 4. Continue the climbing turn until you have reached the Emergency Escape Maneuver altitude and heading. I will inform ATC when you have reached the EEM altitude and heading.
- Missed approach target speed for the low-speed run is 145 knots - VREF30 plus 15 knots. Missed approach target speed for the high-speed run is 165 knots. The flaps are maintained at 20 degrees to the EEM altitude.
- The EEM heading and altitude is 302° and 4200 feet for runway 35 left. For runway 35 center and right, the EEM heading is 036° and the EEM altitude is 3200 feet.

15.0 Specific Pilot-Not-Flying Responsibilities

- I will initiate and conduct appropriate ATC communications.
- I will adjust the RANGE on my map as appropriate for the situation.
- I will be responsible for monitoring the aircraft flight path on both the EADI and the HSI. I will not, however, inform you if you are off course.
- During manual approaches, I will set all functions of the MCP at your command. During automatic approaches, I will set the altitude. For all approaches, I will operate the gear, flaps, and spoilers as you request.
- In the event of an Emergency Escape Maneuver, I will retract the flaps to 20°, raise the landing gear after an indication of a positive climb, and contact ATC.
- I will initiate the normal callouts as previously described.
- I will remind you of any items that you may have forgotten as long as they do not affect the experimental results.

16.0 Integrated AILS Crew Procedures

The following are the procedures that should be used for each approach.

16.1 Initialization

Flaps 20, speed 165, Gear UP; F/D on; Auto-throttle ON/OFF, Autopilot ON/OFF; Lateral guidance mode—LOC; Vertical guidance mode—Altitude Hold with Glide Slope armed. You should assume a high speed approach (165 KIAS & 20 flaps) unless ATC specifically requests you to slow to 135 KIAS.

16.2 After the Emergency Turn Bug Is in View—Conduct Briefing

You should announce, “In the event of an Emergency Escape Maneuver, I plan to turn left to 302 degrees and climb to 4200 feet.” After this emergency turn briefing, we should both mentally review the EEM action steps.

16.3 At the FAF or Glide Slope Intercept Point

I will announce “final approach fix” and will remind you of the emergency turn direction and heading if you have forgotten to conduct the AILS briefing.

16.4 At 1000 Feet

I will announce “1000 feet.” You should respond in accordance with your company’s procedure.

16.5 At 500 Feet

I will announce “500 feet.” You should respond in accordance with your company’s procedure.

16.6 Approaching Minimums

I will announce “approaching minimums” at 350 feet, and “minimums” at 250 feet.

16.7 If You Receive a “TRAFFIC” Alert

If not already in position, you should put your hands on the control wheel and throttles and be prepared to disconnect Autothrottle and Autopilot. Your feet should be ready on the rudder pedals. You should mentally rehearse the specific steps you plan to take if you get a “CLIMB TURN” command.

16.8 If You Receive a “CLIMB TURN” Warning

You should immediately and simultaneously accomplish the procedure previously delineated.

Appendix B

Flight Manual Bulletin

INSTRUCTIONS TO SUBJECT PILOTS, AILS, JUNE, 1999

FLIGHT MANUAL BULLETIN

Insert following the BULLETINS tab. Record on the Bulletin Checklist

Revision 4.0, 6/7/99

AIRBORNE INFORMATION FOR LATERAL SPACING (AILS)

BACKGROUND INFORMATION

In 1993, work was begun on a flight deck-based system that would permit aircraft flying closely spaced parallel approaches to operate in instrument conditions with the equivalent level of safety as under visual conditions with the adjacent traffic in sight. The system, Airborne Information for Lateral Spacing (AILS) is being evaluated at Wallops Flight Facility (WAL) and MSP.

Ground-based equipment required for this system includes a highly accurate approach path defined by Differential GPS rather than conventional ILS localizer and glide path radio signals. This enables certain modifications to be made to the approach paths, thus tailoring them to the specific requirements of AILS. ILS terminology is retained for AILS approaches.

The fundamental conceptual difference between an AILS approach and all other approaches is that airborne technology provides the primary separation assurance with the parallel approach traffic, rather than ATC. This reduces the time delay of multiple people in the control loop.

The approach path is shown in the cockpit in the same manner as an ILS. The approach may be flown on Flight Director or Autopilot. Approach paths for parallel runways may be offset 2° to provide separation on final approach. For the offset approach, Decision Height is not less than 250 feet.

Airborne equipment unique to this system includes:

- Receiver for D-GPS approach path.
- Automatic Dependent Surveillance-Broadcast (ADS-B) transponder equipment with a refresh rate of one-half second.
- Modified map display to provide additional scales of 5.0 and 2.5 nautical miles. To reduce map clutter on the 2.5 scale, the scale index is 1 NM rather than 1.25.
- EADI and ND displays are modified to incorporate AILS requirements.
- TCAS is modified to enunciate warnings required by AILS.
- FMC database and logic modified to include AILS approaches.

Upon receiving clearance for an AILS approach, the flight crew will select the appropriate approach from the menu on the FMS APPROACH page, verify and EXECUTE. This action by the flight crew causes the following operational changes:

- Data link is established with suitably equipped proximate aircraft.
- Verification of correct runway selection is made by the AILS system.
- Transition parameters from TCAS to AILS are established.
- D-GPS Required Navigational Performance (RNP) is confirmed by AILS.
- Special map scale (2.5 NM) is enabled for the approach.

No EICAS error messages are associated with the AILS approaches: Because this is a research effort, the system is set up to work perfectly; therefore no error messages will be generated. However, in an operational environment the appropriate error messages would be listed here.

Resolution of potential and actual conflicts is prioritized so as to result in the maximum safety and minimum disruption to normal flow of traffic. The following principles are applicable to the design of AILS:

1. Alerting features are incorporated that help maintain each aircraft in its assigned airspace. Except for deviations from the localizer course, transient excursions or excessive track angles will not necessarily result in cockpit warnings. **The deviation must pose a threat to another aircraft** before the approach is interrupted. This is done to avoid spurious emergency maneuvers.
2. The system recognizes that either or both aircraft may deviate from their respective assigned airspace and become a threat to proximate traffic.
3. If deviation of one aircraft poses a potential threat to the adjacent aircraft, the priority of alerts is such that the intruding aircraft is issued a Warning and broken out of the approach prior to breaking the adjacent aircraft out. The procedure initiated by the Warning message is called an Emergency Escape Maneuver (EEM). It is displayed on the EADI as CLIMB, TURN, and includes the audio message, "CLIMB, TURN."
4. See Operating Procedures in this Bulletin for specific crew actions. As with any other time-critical maneuver, pilots are expected to respond to an EEM immediately.

SUMMARY OF ALERTS

The following tables summarize those alerts that would be received by an airplane that fails to maintain its prescribed flight path and ultimately **poses a threat** to the adjacent aircraft and those alerts that would be received by an airplane that is **being threatened** by adjacent traffic. Either or both aircraft can be the intruder or evader. Crewmembers must be prepared to respond appropriately to each of the six different alerts.

ALERTS IN COCKPIT OF AIRCRAFT THAT IS DEVIATING FROM COURSE
(Assumes other aircraft is on course)

Basis for Alert	Parameter	Alert Level	Display		Pilot Response
			Visual	Audio	
Course deviation	1 dot LOC	Advisory	LOCALIZER		Return to Course
Course deviation	2 dots LOC	Caution	LOCALIZER		Expediently Return to Course
Potential threat to other aircraft	Projected path	Caution	PATH	PARALLEL APPROACH, PATH	Immediately Return to Course
Imminent threat to other aircraft	Projected path	Warning	flashing CLIMB TURN	CLIMB TURN (repeating)	Execute EEM

ALERTS IN COCKPIT OF AIRCRAFT THAT IS BEING THREATENED
(Assumes threatened aircraft is on course)

Basis for Alert	Parameter	Alert Level	Display		Pilot Response
			Visual	Audio	
Potential threat from intruder	Projected path of intruder	Caution	TRAFFIC	TRAFFIC, PARALLEL APPROACH	Crew awareness, Review Procedure
Imminent threat from intruder	Projected path of intruder	Warning	flashing CLIMB TURN	CLIMB TURN (repeating)	Execute EEM

OPERATING PROCEDURE

Air Traffic Control will vector or provide clearance to final approach in the conventional manner. Prior to receiving clearance for the approach, ATC will advise each aircraft of the type aircraft and relative position of the proximate traffic.

AILS APPROACH

NOTE

- AILS is not authorized with an engine inoperative or any system irregularity that might compromise the approach.
- Fly approach A/P or F/D.
- Fly normal missed approach A/P or F/D.
- Fly EEM MANUAL ONLY. No Autoflight guidance is provided.

PNF FMS ARRIVALS AILS
Select AILS for the appropriate runway. Observe AILS ARMED is enunciated on EADI

C, F/O APPROACH/LANDING BRIEFING
After receiving clearance for AILS approach, the following items will be added to the normal briefing:

- Use of autopilot on approach
- PNF monitor proximate A/C position
- Emergency Escape Maneuver (EEM)

PF, AUTOPILOT (AS DESIRED) ARMED

PF, AUTOTHROTTLE (AS DESIRED) ON
Although not mandatory for AILS approaches, use of autopilot and autothrottle is recommended.

PNF, AILS ACTIVE ANNOUNCE
Displays "AILS" on EADI. Flight mode Annunciations (PITCH and ROLL) are same as on ILS. Map display changes to 2.5 NM scale.

NOTE

TCAS alerts from other than paired aircraft are active during AILS approaches.

PNF, PROXIMATE TRAFFIC MONITOR

PNF, AILS ACTIVE MONITOR
If AILS Caution is enunciated (TRAFFIC Displayed on EADI and aural TRAFFIC, PARALLEL APPROACH), crew should review and be prepared to execute an EEM.

CAUTION

If AILS Traffic Warning is enunciated (flashing CLIMB, TURN displayed on EADI and aural CLIMB, TURN, CLIMB, TURN), PF will accomplish the following procedure aggressively and without delay:

PF, PNF EEM INITIATE

PF, THRUST MAX RATED
Disconnect Autothrottles and aggressively position throttles to Maximum Rated Thrust.

PF, PITCH ALTITUDE APPROX 15°
Disconnect Autopilot and rotate using approximately 3°/second rotation rate. Target speed is VREF30 plus 15 knots.

PF, BANK TARGET 30°
Aggressively roll into a 30° bank turn away from traffic. Continue turn to EEM Heading Bug (approx. 45° away from adjacent approach course). Target altitude as published for EEM.

CAUTION

Do not follow Flight Director during EEM. Flight Director does not bias out of view and will continue to command a return to approach path.

PNF FLAPS (ON ORDER) POSITION 20

PNF GEAR (ON ORDER) UP
Either pilot observe and call positive climb. Pilot flying call for gear up and pilot not flying retract the gear.

PNF EEM MONITOR
PF advise ATC of EEM.

PF PUBLISHED EEM ALTITUDE MAINTAIN

This bulletin will be removed when the information is incorporated into the Flight Manual.

Appendix C

Simulator Briefing and Training Script

Note: Prior to arrival at the simulator, the simulator operator of the IFD will set up for training run “A.” The simulator operator will go to operate and then place the simulator in “HOLD.”

1.0 Simulator Briefing and Training

1.1 Cockpit, General

- Seat and pedal adjustment.
- Verify that the subject’s seat & rudder position will permit adequate rudder position for the EEM.
- Nonstandard large digital clock for researcher use.
- Standard column and yoke.
- Have subject operate the autopilot disconnect switches. Stress the importance of disconnecting the autopilot before starting the EEM.
- Point out that the simulator may not have the normal control breakout characteristics.
- Explain that the top of control column is warm because it has hydraulic fluid running through it.
- IFD has no visual system.

1.2 Communications

- Demonstrate use of MIC SELECT panels.
- Airplane (not simulator) has UHF radio control panel on overhead.
- Speakers may be used during simulator operations.
- Communications will be on L VHF COMM.
- ADF receiver must be ON to receive the AILS aural alerts.

1.3 Overhead Panel

- Simulator construction is not complete and several systems and switches do not work
- Yaw Damper, Hydraulic, Fuel, Bleed Air, and Anti-Ice are operative.
- IRS MODE SEL panel is early design and will not be used for this experiment.
- Fuel cross feed has single button.

1.4 Mode Control Panel (MCP)

- IFD has early style A/P ENGAGE switches (A/P & CWS); airplane has paddle-style levers.
- VNAV, CWS, & back course ILS do not work.
- Prior to each run, the instructor will set the MCP speed to 165 KIAS, set the flaps to 20 degrees, check that the landing gear is UP, and turn both flight directors OFF.
- At the beginning of each run, the instructor will turn on both flight directors and engage the ALTITUDE HOLD and APPROACH modes. If the run is autocoupled, the instructor will also place the Left autopilot in the COMMAND mode and select the SPEED mode.
- At glide slope intercept, the instructor will set the altitude window to the missed approach altitude. Note: Since the missed approach altitude and the EEM altitude are the same for this experiment, you can re-engage the flight director for pitch and roll guidance after you have completed the EEM.

1.5 Electronic Attitude Deviation Indicator/Primary Flight Display (EADI/PFD)

- Left side display is modified for research purposes.
- Point out where the AILS status is displayed and where the various visual alerts (LOCALIZER, PATH, TRAFFIC, CLIMB TURN) will appear.
- Point out the expanded localizer scale and its pointer.

1.6 Horizontal Situation Indicator/Navigation Display (HSI/ND)

- Left side display is modified for research purposes.
- Have subject operate the map scale selector knob and point out that the resolution is doubled when in the AILS mode. Also point out 1.2 and the 1.0 NM labels on the 2.5 NM scale.
- Point out that the subject can use either the ILS/APP, HSI, MAP, or MAP CENTER mode of the HSI.
- Point out that each approach will start out with an erroneous wind value that will be integrated out in approximately two minutes. The actual wind is zero for all simulator approaches.

1.7 Engine Controls

- RB 211 Engines (N1, N2, and N3) are installed on the airplane and are simulated in the IFD.
- Since all EEM's will be accomplished manually, the takeoff/Go-Around (TO/GA) switches will not be used.
- Point out and instruct the subject to operate the throttle disconnect switches.

1.8 Center Console

- The gray FMS Control Display Units (CDU) are Smith Industries units that have been modified for research. The current database does not contain all the waypoints that are shown on the approach plates.
- A set of CRT lighting controls is located on the pedestal immediately forward of the throttle quadrant.
- Trim Panel is moved forward to a position aft of, and adjacent to, the Engine Fire panel.

1.9 Speed Brake

- The speedbrake lever will be armed for all approaches in the simulator.
- In the airplane, the speedbrakes will not be armed if a touch-and-go is planned.

1.10 Flaps

Show the subject the 20° flap gate that will be used for normal go-arounds and for the EEM when the speed is 135 KIAS. Note: When the speed is 165 KIAS, the flaps will already be at 20 degrees.

2.0 Simulator Training

Now we will begin the simulator training. The purpose of this training is to give you some hands on AILS training to ensure that you are trained to proficiency before we begin the data runs. Trained to proficiency means that you will be able to safely fly AILS approaches using the prescribed procedure.

All approaches in the simulator are initialized at a gross weight of 192.0, on the localizer, 14.0 NM from the runway threshold. The winds for all approaches will be light and variable. If you reach the 250 foot decision height (DH) on any of the approaches, you should execute a normal missed approach.

After the FAF (10.0 DME), the runs will be flown at either of two stabilized approach speeds, 165 or 135 knots. All approaches are initialized with 20 degrees of flaps at an airspeed of 165 KIAS. You should always plan to make a high speed approach (165 KIAS) unless ATC instructs you to slow to 135 KIAS. The gear should be down and the “BEFORE LANDING” checklist completed prior to the final approach fix (leaving 3200 feet). The 135 KIAS speed is 5 knots above VREF30 speed of 130 KIAS. Go-around and EEM will be conducted at 145 KIAS or 15 knots above the VREF30 speed. The flaps will be retracted to 20 degrees as part of the go-around or EEM procedure.

High speed approaches are initialized with 20 degrees of flaps at an airspeed of 165 KIAS. The gear should be down and the “BEFORE LANDING” checklist completed by the 10.0 DME fix. While this speed and configuration is nonstandard for airline operations, it is needed for research purposes. The 165 KIAS speed is 25 knots above the VREF20 speed of 140. Because of the excess speed, go-arounds or EEM’s are also flown at 165 knots with the flaps remaining at 20 degrees.

On any approach, you may receive Caution or Warning alert other than AILS. You should respond to these alerts in accordance with your airline training. For example, if you receive a WINDSHEAR alert, respond as you have been trained by your company.

2.1 First Procedural Run—Manual

Instructor note: It is important that the instructor does not conduct any AILS training, including reinforcement of the classroom briefing, during the first three runs. This is because part of the experiment is to determine the subject's knowledge based solely on the classroom training. Explanation of simulator differences and setup items are permitted. After the third run, a review of the key points of AILS is appropriate and recommended.

SCRIPT: The purpose of the first run is to give you some practice in flying this simulator and using normal procedures. AILS will not be on. I will function as a normal line first officer.

SETUP: Training scenario "A" (4,200 feet, on localizer RW 35L, 14 NM from touchdown, speed 165 knots, Flaps 20, Gear UP, AILS OFF, no intrusion, manual approach and a manually flown missed approach). Note: Prior to operating, the instructor will verify the correct speed in the MCP, the corresponding flap setting, gear UP and both flight directors OFF. As soon as the simulator goes to operate, the instructor will turn ON both FLIGHT DIRECTORS and select the ALTITUDE HOLD and APPROACH modes.

CRITERIA: None—practice only.

Subject pilot will fly approach to a point approximately 250 feet AFE and then disconnect the autopilot and fly a normal missed approach. The following points will be discussed and emphasized:

- ATC communications (check in with tower, missed approach, EEM and completion of EEM).
- Normal approach call outs by PNF (glide slope intercept, 1,000 feet AFE, 500 feet AFE, approaching minimums, minimums)
- Missed approach procedure (stress autopilot disconnect and appropriate pitch attitude for GA with full power)

2.2 Second Run—Manual Control (With Unanticipated Windshear)

Instructor note: It is important that the instructor does not conduct any AILS training, including reinforcement of the classroom briefing, during the first three runs. This is because part of the experiment is to determine the subject's knowledge based solely on the classroom training. Explanation of simulator differences and setup items are permitted. After the third run, a review of the key points of AILS is appropriate and recommended.

SCRIPT: This is another manual run for you to practice normal procedures. You may or may not receive an alert. If there is an alert, it may or may not command an emergency escape maneuver EEM. Other standard alerts, such as windshear, may be introduced. You should use all the procedures and call outs that we have talked about. This is an approach to runway 35L. I will be acting as an inexperienced copilot and will not help you very much. Do you have any questions?

SETUP: Training Scenario "A" (4,200 feet, on localizer RW 35L, 14 NM from touchdown, speed 165 knots, Flaps 20, Gear UP, AILS OFF, no intrusion, manually flown approach, with windshear). Note: Prior to operating, the instructor will verify the correct speed in the MCP, the corresponding flap setting, gear UP and both flight directors OFF. As soon as the simulator goes to operate, the instructor will turn ON both FLIGHT DIRECTORS and select, ALTITUDE HOLD and APPROACH.

CRITERIA: None—baseline data only.

- Discuss any procedural deviations.
- Windshear recovery maneuver is for data collection only and will not be debriefed.

2.3 Third Run—Manual Control (With Unanticipated Intrusion and EEM)

Instructor note: It is important that the instructor does not conduct any AILS training, including reinforcement of the classroom briefing, during the first three runs. This is because part of the experiment is to determine the subject's knowledge based solely on the classroom training. Explanation of simulator differences and setup items are permitted. After the third run, a review of the key points of AILS is appropriate and recommended.

SCRIPT: This is a third manual run for you to practice the AILS procedures. You may or may not receive an alert. If there is an alert, it may or may not command an emergency escape maneuver EEM. Other standard alerts, such as windshear, may be introduced. You should use all the procedures and call outs that we have talked about. This is an approach to runway 35L. I will be acting as an inexperienced copilot and will not help you very much. Do you have any questions?

SETUP: Training Scenario “B” (4,200 feet, on localizer RW 35L, 14 NM from touchdown, speed 165 knots, Flaps 20, Gear UP, AILS ON, with intrusion, manually flown approach). Note: Prior to operating, the instructor will verify the correct speed in the MCP, the corresponding flap setting, gear UP and both flight directors OFF. As soon as the simulator goes to operate, the instructor will turn ON both FLIGHT DIRECTORS and select ALTITUDE HOLD and APPROACH.

CRITERIA: None—baseline data collection only.

- Discuss any AILS procedural deviations (briefing, tracking, ground track symbol, preparation at TRAFFIC alert, hands & feet on/near controls).
- Observe and debrief pitch, airspeed and heading control during EEM.
- Conduct quick review of AILS system (both EADI & HSI).

2.4 Demonstrate Intruder Alerts & EEM—Autocoupled & Manual

SCRIPT: The purpose of this run is to demonstrate the four levels of alerts that an intruder aircraft would receive before you will have to alter your course. In this run, assume that we are the intruder aircraft. At a predetermined point, I will make a 10-degree turn towards the other aircraft. I will maintain that heading so you can observe the four alerts. When I receive the red “CLIMB TURN” warning, I will perform the EEM as we discussed earlier. Any questions?

SETUP: Training scenario “A” (4,200 feet, on localizer RW 35L, 14 NM from touchdown, speed 165 knots, Flaps 20, Gear UP, AILS on, with intrusion, autocoupled & manual approach). Note: Prior to operating, the instructor will verify the correct speed in the MCP, the corresponding flap setting, gear UP and both flight directors OFF. As soon as the simulator goes to operate, the instructor will turn ON both FLIGHT DIRECTORS, select the SPEED mode of the autothrottle system, ALTITUDE HOLD, APPROACH, and left Autopilot in COMMAND. Instructor will make a right 10 degree bank turn to a

heading of 021 degrees—30 degree intrusion—when the blue line of the extra monitor (behind subject) crosses the nose of ownship.

CRITERIA: None—demonstration only.

- Demonstrate AILS special approach briefing.
- Instructor will point out one-dot Advisory.
- Instructor will point out two-dot Caution.
- Instructor will point out Path Caution.
- Instructor will point out and respond to “CLIMB-TURN” Warning.

2.5 Emergency Escape Maneuver (EEM) Proficiency—Autocoupled

SCRIPT: The purpose of this run is to practice and develop proficiency in EEM techniques. It is important to recognize that the receipt of an EEM is truly an emergency, where you could be involved in a midair collision if you do not take immediate, aggressive action. You will be given the opportunity to practice several EEM's.

The technique I use is the following:

When I first receive the Traffic alert, I will ensure that my hands and feet are in position on the controls and quickly review each step of the EEM. Upon receipt of the “CLIMB-TURN” Warning, I will simultaneously

- Disconnect the autothrottle with my right thumb and aggressively push the throttles forward.
- Disconnect the autopilot with my left thumb and aggressively pull and rotate the yoke away from adjacent parallel traffic. I will attempt to use a pitch rate of about 3 degrees per second and a roll rate of about 5–10 degrees per second. In order to achieve this rate, it is necessary to use about 25 percent of the rudder throw to coordinate the turn.
- Callout, “Go-around thrust; flaps 20”; after observing a positive climb, callout “Positive climb, gear up.”
- Maintain a 30 degree bank turn away from parallel traffic until rolling out on the EEM heading bug; 30 degrees is the target bank angle and a slight overbank is acceptable.
- Target airspeed is VREF30 plus 15 knots—145 knots for slow speed runs and 165 knots for high speed runs.

SETUP: Training scenario “B” (4,200 feet, on localizer RW 35L, 14 NM from touchdown, speed 165 knots, Flaps 20, Gear UP, AILS on, with intrusion, autocoupled approach). Note: Prior to operating, the instructor will verify the correct speed in the MCP, the corresponding flap setting, gear UP and both flight directors OFF. As soon as the simulator goes to operate, the instructor will turn ON both FLIGHT DIRECTORS, select the SPEED mode of the autothrottle system, ALTITUDE HOLD and APPROACH. The Left Autopilot will be placed in the COMMAND mode.

CRITERIA: None—Practice EEM to control pitch and bank. Observe and offer comments.

- Reaction time (approximately 2 seconds)
- Autopilot and Autothrottle disconnect
- Throttles manually advanced to approximately Go-around Thrust
- Pitch rate (approximately 3 degrees per second)
- Roll rate (approximately 5–10 degrees per second)
- Bank angle (approximately 30 degrees)
- Speed control (approximately 145 knots)
- Turns to correct EEM heading (302°)
- Levels at correct EEM altitude (4,200 feet)

Subject will demonstrate at least one satisfactory maneuver before proceeding to the full practice runs.

2.6 Emergency Escape Maneuver (EEM) Proficiency—Manual

SCRIPT: The purpose of this run is to practice and develop proficiency in EEM techniques during a manually flown approach.

SETUP: Training scenario “B” (4,200 feet, on localizer RW 35L, 14 NM from touchdown, speed 165 knots, Flaps 20, Gear UP, AILS ON, with intrusion, manual approach). Note: Prior to operating, the instructor will verify the correct speed in the MCP, the corresponding flap setting, gear UP and both flight directors OFF. As soon as the simulator goes to operate, the instructor will turn ON both FLIGHT DIRECTORS, select ALTITUDE HOLD and APPROACH.

CRITERIA: None—Practice EEM to control pitch and bank. Observe and offer comments.

- Reaction time (approximately 2 seconds)
- Autopilot and Autothrottle disconnect
- Throttles manually advanced to approximately Go-around Thrust
- Pitch rate (approximately 3 degrees per second)
- Roll rate (approximately 5–10 degrees per second)
- Bank angle (approximately 30 degrees)
- Speed control (approximately 145 knots)

- Turns to correct EEM heading (302°)
- Levels at correct EEM altitude (4,200 feet)

Subject will demonstrate at least one satisfactory maneuver before proceeding to the full practice runs.

2.7 Evaluation Run—Manual Control

SCRIPT: Now let's put it all together. This will be a manually flown AILS approach with an intrusion and an EEM. You should use all the procedures and call outs that we have previously discussed. This is an approach to runway 35L. I will be acting as an inexperienced copilot and will not help you very much. At the conclusion of each run, I will debrief you. Do you have any questions?

SETUP: Training scenario "B" (4,200 feet, on localizer RW 35L, 14 NM from touchdown, speed 165 knots, Flaps 20, Gear UP, AILS on, with intrusion, manually flown approach). Note: Prior to operating, the instructor will verify the correct speed in the MCP, the corresponding flap setting, gear UP and both flight directors OFF. As soon as the simulator goes to operate, the instructor will turn ON both FLIGHT DIRECTORS and select ALTITUDE HOLD and APPROACH.

CRITERIA: Subject will demonstrate appropriate

- Reaction time (approximately 2 seconds)
- Autopilot and/or Autothrottle disconnect
- Throttles manually advanced to approximately Go-around Thrust
- Pitch rate (approximately 3 degrees per second)
- Roll rate (approximately 5–10 degrees per second)
- Bank angle (approximately 30 degrees)
- Speed control (approximately 145 knots)
- Turns to correct EEM heading (approximately 302°)
- Levels at correct EEM altitude (approximately 4,200 feet)

2.8 Evaluation Run—Autocoupled

SCRIPT: This will be an autocoupled AILS approach with an intrusion and an EEM. You should use all the procedures and call outs that we have previously discussed. This is an approach to runway 35L. I will be acting as an inexperienced copilot and will not help you very much. At the conclusion of each run, I will debrief you. Do you have any questions?

SETUP: Training scenario "B" (4,200 feet, on localizer RW 35L, 14 NM from touchdown, speed 165 knots, Flaps 20, Gear UP, AILS on, with intrusion, autocoupled approach). Note: Prior to operating, the instructor will verify the correct speed in the MCP, the corresponding flap setting, gear UP and both

flight directors OFF. As soon as the simulator goes to operate, the instructor will turn ON both FLIGHT DIRECTORS, select the SPEED mode of the autothrottle system, ALTITUDE HOLD, APPROACH and left Autopilot in COMMAND.

CRITERIA: Subject will demonstrate appropriate

- Reaction time (approximately 2 seconds)
- Autopilot and/or Autothrottle disconnect
- Throttles manually advanced to approximately Go-around Thrust
- Pitch rate (approximately 3 degrees per second)
- Roll rate (approximately 5–10 degrees per second)
- Bank angle (approximately 30 degrees)
- Speed control (approximately 145 knots)
- Turns to correct EEM heading (approximately 302°)
- Levels at correct EEM altitude (approximately 4,200 feet)

Appendix D

Quantitative Data Analysis Details

A multivariate analysis of variance (MANOVA) was used to test the effect of the following factors on both the reaction time and miss-distance: flight control mode, runway separation, scenario, aircraft speeds, and interaction effects of these combined factors. The t-tests were conducted to test the following: the mean reaction time would be less than 2 sec and the mean miss-distance would be equal to 1200 ft. In addition, a chi-square (χ^2) test of the variance was conducted for a miss-distance of 1200 (± 500) ft which translates to a standard deviation of 166 ft. These tests not only consider the individual responses but also the correlation and covariances between and within the factors and responses.

Miss-Distance

The hypotheses used in the miss-distance MANOVA analysis are as follows:

$$\text{Mean MD}_A = \text{Mean MD}_M$$

$$\text{Mean MD}_A \neq \text{Mean MD}_M$$

$$\text{Mean MD}_{25} = \text{Mean MD}_{34}$$

$$\text{Mean MD}_{25} \neq \text{Mean MD}_{34}$$

where $\text{Mean MD}_A = \text{Mean MD}_M$ (null hypothesis) states that the average miss-distance while flying in the autopilot mode (MD_A) is the same as the average miss-distance while flying in the manual mode (MD_M). The alternative hypothesis states that the average miss-distance while flying in the autopilot mode is not the same as the average miss-distance while flying in the manual mode. Similarly, $\text{Mean MD}_{25} = \text{Mean MD}_{34}$ (null hypothesis) states that the average miss-distance while approaching runways that are 2500 ft apart (MD_{25}) is the same as the average miss-distance while approaching runways that are 3400 ft apart (MD_{34}). The alternative hypothesis states that the reaction time is not the same in these cases.

The MANOVA analysis (table D1) failed to reject both null hypotheses based upon a significance level of $\alpha = 0.05$. This means that based on the experimental results, there is neither a significant difference between MD_A and MD_M nor is there a significant difference between the mean MD_{25} and mean MD_{34} .

Table D1. Summary of Multivariate Analysis of Variance for Miss-Distance

Source	Degrees of freedom	Sum of squares		Adjusted mean square	F	P
		Sequential	Adjusted			
Control mode	1	237 938	241 913	241 913	1.05	0.306
Runway separation	1	413 047	413 047	413 047	1.79	0.181
Error	313	72 073 323	72 073 323	230 266		
Total	315	72 724 308				

For the t-test of the mean miss-distance, the specification was that the miss-distance must be 1200 ± 500 ft. This specification translates to the following hypothesis:

Mean MD = 1200.0 ft

Mean MD \neq 1200.0 ft

The null hypothesis states that the mean miss-distance is equal to 1200 ft. The alternative hypothesis states that the mean miss-distance is not equal to 1200 ft. The null hypothesis was rejected (table D2). The mean miss-distance was much larger (2236 ft) than the prespecified target of 1200 ft.

Table D2. Summary of Miss-Distance t-Test

Variable	N	Mean	Standard deviation	Standard error mean	T	P
Miss-distance	318	2236	479	26.9	38.57	0.0000

The χ^2 test for the variance of the miss-distance showed that the recorded miss-distance variance is significantly larger than the specified one.

Pilot Reaction Time

The minimum pilot reaction time for each run was derived from three recorded flight control responses: time to advance the throttle, time to pull the column, and time to turn the wheel. The number of times that each control action was the minimum reaction time was examined. The results of this examination are illustrated in table D3.

Table D3. Dominant Minimum Reaction Time According to Control Mode

Control mode	Runway separation	Minimum reaction time, percent, for—			Grand total, percent
		Throttle	Wheel	Column	
Autopilot	2500	63	36	1	
	3400	75	24	1	
Total		69	30	1	100
Manual	2500	51	41	8	
	3400	54	32	14	
Total		53	37	11	100
Grand total		61	33	6	100

It should be noted that the subjects were briefed to advance the throttle in response to an EEM alert, thus giving them power to climb and turn away from the intruder. From table D3, advancing the throttle was the first response to the majority of the alerts (61%).

The hypotheses used in the average reaction time MANOVA analysis examining flight control mode, autopilot or manual, prior to the EEM and runway separation are as follows:

$$\text{Mean RT}_A = \text{Mean RT}_M$$

$$\text{Mean RT}_A \neq \text{Mean RT}_M$$

$$\text{Mean RT}_{25} = \text{Mean RT}_{34}$$

$$\text{Mean RT}_{25} \neq \text{Mean RT}_{34}$$

where $\text{Mean RT}_A = \text{Mean RT}_M$ (null hypothesis) states that the average reaction time while flying in the autopilot mode (RT_A) is the same as the average reaction time while flying in the manual mode (RT_M). The alternative hypothesis states that the average reaction time while flying in the autopilot mode is not the same as the average reaction time while flying in the manual mode. Similarly, $\text{Mean RT}_{25} = \text{Mean RT}_{34}$ (null hypothesis) states that the average reaction time while approaching runways that are 2500 ft apart (RT_{25}) is the same as the average reaction time while approaching runways that are 3400 ft apart (RT_{34}). The alternative hypothesis states that the reaction time is not the same in these cases.

The first null hypothesis was rejected with a P-value of 0.0000 (table D4); this means that there is a statistically significant difference between the mean RT_A and the mean RT_M . We failed to reject the second null hypothesis; this means that there is not a significant difference between the mean RT_{25} and the mean RT_{34} .

Table D4. Summary of Multivariate Analysis of Variance for Reaction Time

Source	Degrees of freedom	Sum of squares		Adjusted mean square	F	P
		Sequential	Adjusted			
Control mode	1	3.919	3.9088	3.9088	20.07	^a 0.0000
Runway separation	1	0.1594	0.1594	0.1594	0.82	0.366
Error	313	60.9515	60.9515	0.1947		
Total	315	65.0299				

^aSignificant at $\alpha = 0.05$.

In addition to flight control mode and runway separation, it was prespecified that the minimum reaction time should be less than 2 sec; this translates to the following hypothesis:

$$\text{Mean RT} = 2.0$$

$$\text{Mean RT} < 2.0$$

The null hypothesis states that the average reaction time is equal to 2.00 sec. The alternative hypothesis states that the average reaction time is less than 2.00. The null hypothesis was rejected with a P-value of 0.0000 (table D5). This means that based upon experimental results the average reaction time is indeed below the 2-sec limit.

Table D5. Summary of Pilot Reaction t-Test

Variable	N	Mean	Standard deviation	Standard error mean	T	P
Reaction time	316	1.0049	0.4544	0.0256	-38.93	0.0000

Appendix E

AILS Pilot Questionnaire

Please answer the following questions as accurately as you can. We want your personal opinion on questions that are important to us. For each question, please mark the number that best describes your opinion. Note that for the first seven questions, one of five answers is possible. For each question, please select one of the numbers.

1. From a real-world line-operations viewpoint, would AILS be practical (please exclude equipment specific issues such as the displays and alerting system)?

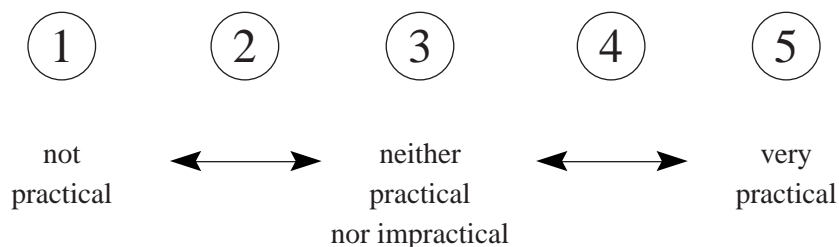

2. Were the operational procedures clear and easy to understand?

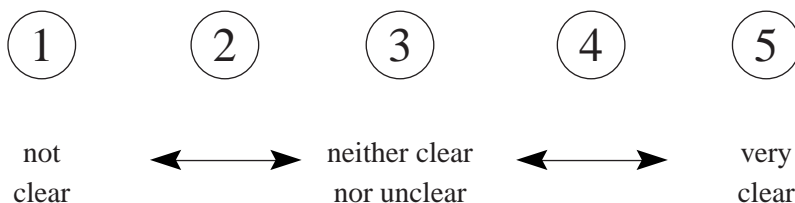

3. Was the AILS training adequate?

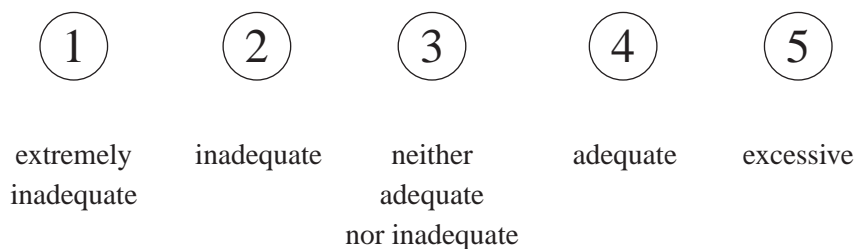

4. Regarding your safety (collision risk) relative to the other aircraft, the situation was:



5. Were the alerts clear and unambiguous (did you know what each alert meant)?

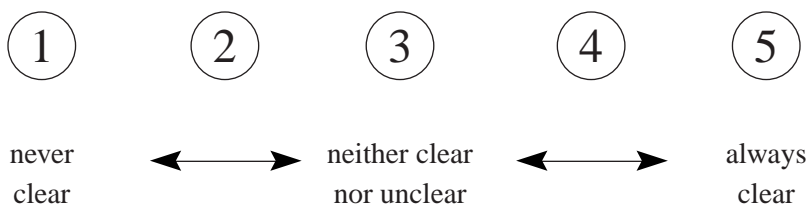

6. When you received an alert (advisory, caution, or warning), did you understand the necessary response?



7. Was the procedure for the Emergency Escape Maneuver (EEM) reasonable?



8. Was the Emergency Escape Maneuver (EEM) easy to perform?

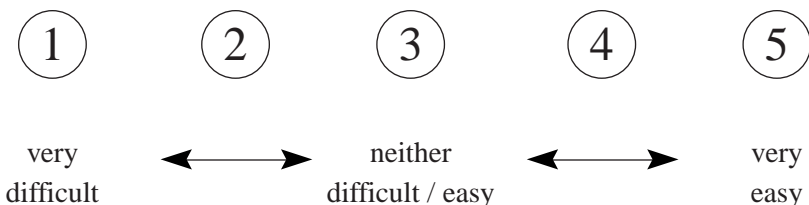

9. Which flight control mode would you use to fly the AILS approach?



10. Was your response to the EEM alert slowed by flying an autopilot approach (that is, the manual takeover to perform the EEM)?

1

2

3

greatly

slightly

not at
all

11. Do you think the 2.5 nmi map scale setting was necessary for AILS operations?

1

2

3

4

5

not
important



no difference



very
important

12. Did the background ATC communications give you a realistic perception of day-to-day operations?

1

2

3

4

5

not
realistic



somewhat
realistic



very
realistic

13. Please provide your comments on the AILS operational concept:

No specific comment.

14. While the AILS concept is not dependent on the specific implementation of the alerts that were presented, it would be useful to know if you had any comments on the alerts.

No specific comment.

15. While the AILS concept is not dependent on the specific implementation of the displays that were presented, it would be useful to know if you had any comments on the displays.

No specific comment.

16. Please provide your comments on the Emergency Escape Maneuver (EEM).

No specific comment.

17. During the experiment, did you pick up any technical cues about how the system is designed to help you be more prepared for the EEM? (e.g., color changes, symbol changes, etc.) If so, please state what they were, you may prefer to discuss it with the researchers.

None evident to me.

18. Do you have any other comments?

No other comments.

REPORT DOCUMENTATION PAGE

Form Approved
OMB No. 0704-0188

Public reporting burden for this collection of information is estimated to average 1 hour per response, including the time for reviewing instructions, searching existing data sources, gathering and maintaining the data needed, and completing and reviewing the collection of information. Send comments regarding this burden estimate or any other aspect of this collection of information, including suggestions for reducing this burden, to Washington Headquarters Services, Directorate for Information Operations and Reports, 1215 Jefferson Davis Highway, Suite 1204, Arlington, VA 22202-4302, and to the Office of Management and Budget, Paperwork Reduction Project (0704-0188), Washington, DC 20503.

1. AGENCY USE ONLY (Leave blank)	2. REPORT DATE March 2001	3. REPORT TYPE AND DATES COVERED Technical Publication	
4. TITLE AND SUBTITLE Simulator Evaluation of Airborne Information for Lateral Spacing (AILS) Concept		5. FUNDING NUMBERS WU 576-02-11-17	
6. AUTHOR(S) Terence S. Abbott and Dawn M. Elliott			
7. PERFORMING ORGANIZATION NAME(S) AND ADDRESS(ES) NASA Langley Research Center Hampton, VA 23681-2199		8. PERFORMING ORGANIZATION REPORT NUMBER L-18036	
9. SPONSORING/MONITORING AGENCY NAME(S) AND ADDRESS(ES) National Aeronautics and Space Administration Washington, DC 20546-0001		10. SPONSORING/MONITORING AGENCY REPORT NUMBER NASA/TP-2001-210665	
11. SUPPLEMENTARY NOTES			
12a. DISTRIBUTION/AVAILABILITY STATEMENT Unclassified-Unlimited Subject Category 03 Availability: NASA CASI (301) 621-0390		12b. DISTRIBUTION CODE	
13. ABSTRACT (Maximum 200 words) The Airborne Information for Lateral Spacing (AILS) concept is designed to support independent parallel approach operations to runways spaced as close as 2500 ft. This report describes the AILS operational concept and the results of a ground-based flight simulation experiment of one implementation of this concept. The focus of this simulation experiment was to evaluate pilot performance, pilot acceptability, and minimum miss-distances for the rare situation in which an aircraft on one approach intrudes into the path of an aircraft on the other approach. Results from this study showed that the design-goal mean miss-distance of 1200 ft to potential collision situations was surpassed with an actual mean miss-distance of 2236 ft. Pilot reaction times to the alerting system, which was an operational concern, averaged 1.11 sec, well below the design-goal reaction time of 2.0 sec. These quantitative results and pilot subjective data showed that the AILS concept is reasonable from an operational standpoint.			
14. SUBJECT TERMS Aircraft operations; Closely spaced parallel approach; Aircraft displays			15. NUMBER OF PAGES 71
			16. PRICE CODE A04
17. SECURITY CLASSIFICATION OF REPORT Unclassified	18. SECURITY CLASSIFICATION OF THIS PAGE Unclassified	19. SECURITY CLASSIFICATION OF ABSTRACT Unclassified	20. LIMITATION OF ABSTRACT UL