

NASA / TM-1998-206930

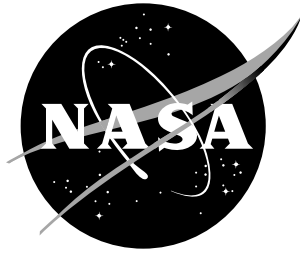

Flight Demonstration of Integrated Airport Surface Technologies for Increased Capacity and Safety

*Denise R. Jones, Steven D. Young, Robert W. Wills, Kathryn A. Smith,
Floyd S. Shipman, Wayne H. Bryant, and Dave E. Eckhardt, Jr.
Langley Research Center, Hampton, Virginia*

February 1998

The NASA STI Program Office ... in Profile

Since its founding, NASA has been dedicated to the advancement of aeronautics and space science. The NASA Scientific and Technical Information (STI) Program Office plays a key part in helping NASA maintain this important role.

The NASA STI Program Office is operated by Langley Research Center, the lead center for NASA's scientific and technical information. The NASA STI Program Office provides access to the NASA STI Database, the largest collection of aeronautical and space science STI in the world. The Program Office is also NASA's institutional mechanism for disseminating the results of its research and development activities. These results are published by NASA in the NASA STI Report Series, which includes the following report types:

- TECHNICAL PUBLICATION. Reports of completed research or a major significant phase of research that present the results of NASA programs and include extensive data or theoretical analysis. Includes compilations of significant scientific and technical data and information deemed to be of continuing reference value. NASA counter-part of peer reviewed formal professional papers, but having less stringent limitations on manuscript length and extent of graphic presentations.
- TECHNICAL MEMORANDUM. Scientific and technical findings that are preliminary or of specialized interest, e.g., quick release reports, working papers, and bibliographies that contain minimal annotation. Does not contain extensive analysis.
- CONTRACTOR REPORT. Scientific and technical findings by NASA-sponsored contractors and grantees.
- CONFERENCE PUBLICATION. Collected papers from scientific and technical conferences, symposia, seminars, or other meetings sponsored or co-sponsored by NASA.
- SPECIAL PUBLICATION. Scientific, technical, or historical information from NASA programs, projects, and missions, often concerned with subjects having substantial public interest.
- TECHNICAL TRANSLATION. English-language translations of foreign scientific and technical material pertinent to NASA's mission.

Specialized services that help round out the STI Program Office's diverse offerings include creating custom thesauri, building customized databases, organizing and publishing research results ... even providing videos.

For more information about the NASA STI Program Office, see the following:

- Access the NASA STI Program Home Page at <http://www.sti.nasa.gov>
- E-mail your question via the Internet to help@sti.nasa.gov
- Fax your question to the NASA Access Help Desk at (301) 621-0134
- Phone the NASA Access Help Desk at (301) 621-0390
- Write to:
NASA Access Help Desk
NASA Center for AeroSpace Information
800 Elkridge Landing Road
Linthicum Heights, MD 21090-2934

NASA / TM-1998-206930

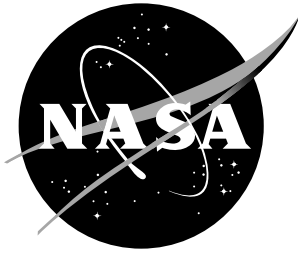

Flight Demonstration of Integrated Airport Surface Technologies for Increased Capacity and Safety

*Denise R. Jones, Steven D. Young, Robert W. Wills, Kathryn A. Smith,
Floyd S. Shipman, Wayne H. Bryant, and Dave E. Eckhardt, Jr.
Langley Research Center, Hampton, Virginia*

National Aeronautics and
Space Administration

Langley Research Center
Hampton, Virginia 23681-2199

February 1998

Available from the following:

NASA Center for AeroSpace Information (CASI)
800 Elkridge Landing Road
Linthicum Heights, MD 21090-2934
(301) 621-0390

National Technical Information Service (NTIS)
5285 Port Royal Road
Springfield, VA 22161-2171
(703) 487-4650

SUMMARY

A flight demonstration was conducted using a research aircraft to show a system of integrated technologies that addressed airport surface movement area capacity and safety by providing pilots with enhanced situational awareness information. The technologies utilized consisted of an electronic moving map display in the cockpit, a Differential Global Positioning System (DGPS) receiver, a high speed very high frequency (VHF) data link, an Airport Surface Detection Equipment (ASDE-3) radar, and the Airport Movement Area Safety System (AMASS). The research aircraft identification was presented to an air traffic controller on an AMASS display. The onboard electronic map included the display of taxi routes, hold instructions, and clearances, which were sent to the research aircraft via data link by the controller. The map also displayed the positions of other traffic and warning information, which were sent automatically from the ASDE-3/AMASS system. This paper describes the flight demonstration and test results.

INTRODUCTION

The U.S. aviation industry is investing \$6 billion over 20 years to increase airport capacity due to the gap between the industry's desired capacity and the ability of the National Airspace System to handle the increased air traffic. The Federal Aviation Administration (FAA) reported that currently 23 of the largest U.S. airports each experience more than 20,000 hours of delays every year, and that by the year 2000, 40 major airports are likely to be experiencing delays of this magnitude [1]. Furthermore, these air traffic delays were estimated to cost \$3 billion for airline operations and \$6 billion for passenger delays in 1990. These costs are projected to increase 50 percent in 10 years based on current trends. Action must be taken to safely increase airport capacity of existing airport facilities while reducing controller and pilot workload. The FAA plans to address these concerns by providing air traffic control, the airlines, and airport management with positive identification of surface targets on the movement area; providing pilots with airport safety alerts; providing controllers with automated warnings of potential and actual runway incursions; providing a surface traffic planning capability; and providing an automated method of sending instructions, such as taxi route clearances, to aircraft.¹

Similarly, the National Aeronautics and Space Administration's (NASA) Terminal Area Productivity (TAP) Program was established, in cooperation with the Federal Aviation Administration, to develop and demonstrate airborne and ground technologies and procedures to safely increase terminal area capacity. The TAP program is developing technologies to reduce aircraft spacing in the terminal area, enhance air traffic management and reduce controller workload, improve low visibility landing and surface operations, and integrate aircraft and air traffic systems. The goal of this work is to provide technology and operating procedures for safely achieving clear-weather terminal area capacity in instrument-weather conditions. The TAP program consists of several program elements, including Reduced Separation Operations (RSO), Air Traffic Management (ATM), Low Visibility Landing and Surface Operations (LVLASO), and Air Traffic Control-Aircraft Systems Integration (AASI). The goal of the LVLASO element is to improve the efficiency of airport surface operations for commercial aircraft operating in weather conditions to Category IIIB² while maintaining a high degree of safety. This will be accomplished by developing systems for reducing runway occupancy time, improving the efficiency of taxi operations, and providing the methodology for the integration of flight deck systems with surface automation systems and tower guidance.

This paper describes a flight demonstration that was conducted as part of the TAP LVLASO element, which addressed many of the FAA and TAP program issues. Quantitative and qualitative results are also discussed. Appendix A contains a list of commonly used acronyms.

¹ Obtained from the ASTA System Design Overview, Federal Aviation Administration.

² Category IIIB is defined by a range of visibility (150' to 700') and decision height (0' to 50').

FLIGHT DEMONSTRATION

The flight demonstration was conducted by the NASA Langley Research Center (LaRC) in conjunction with industry partners from Westinghouse Norden Systems and ARINC, Incorporated. The goals of the testing were (1) to demonstrate an integrated system that would provide the pilot with enhanced situational awareness information to safely increase the traffic capacity on the airport surface movement area and (2) to identify system integration issues. The demonstration was conducted at the Atlantic City International (ACY) airport in June 1995 with the cooperation of the FAA Technical Center.

Demonstration Technologies

The demonstration showed an integration of airborne and ground technologies developed by each of the partners as depicted in figure 1. The airborne technologies were implemented on the Transport Systems Research Vehicle (TSRV), the first production Boeing 737-100 built, which is a NASA LaRC research aircraft [2]. The TSRV has been extensively modified to accommodate research flight testing through the addition of a research flight deck (RFD) (fig. 2). The RFD is located in the aircraft cabin and can be reconfigured to support other research programs. The forward flight deck is a conventional Boeing 737 cockpit that provides operational support and safety backup. The following sections describe the demonstration technologies in detail.

ASDE-3 Radar -- The Airport Surface Detection Equipment (ASDE-3) is an advanced surface surveillance radar developed by Westinghouse Norden Systems as part of the FAA's air traffic control modernization program of the 1980's. Norden is installing 40 systems at 37 of the major United States airports. At the time of the LVLASO demonstration, 29 ASDE-3 systems were fully installed and 22 of those were commissioned.

ASDE-3 produces a radar image of the airport surface to aid ground controllers in managing surface traffic even under severely limited visibility conditions [3]. It was designed to meet the requirements listed in table 1. ASDE-3 consists of three major subsystems: antenna, transmitter/receiver, and display subsystem (fig. 3).

Maximum weather penetration is assured through frequency agility, adaptive gain and threshold control, and a circular polarized antenna. The antenna operates in the radio frequency (RF) range of 15.7 to 17.7 GHz (K_u band). It is protected by a transparent RF radome that is attached to the antenna so that they rotate together. This assembly is called a rotodome (fig. 4). The aerodynamic rotodome rotates at 60 RPM which results in one second updates of target returns. Radar clutter from the returns from different surface areas and weather conditions is minimized by setting different adaptive thresholds for various surface areas, (i.e. runways and taxiways, locations adjacent to runways and taxiways, and all other locations).

The ASDE-3 display subsystem provides controllers with a clear and accurate representation of the airport traffic situation by converting the radar's polar coordinate data to a Cartesian coordinate (X,Y) representation for display on a plan view electronic map of the airport surface. The capability exists to store up to 100 predefined display settings. Each display format consists of a background window with two insets. The controller can dynamically adjust the display settings and control the size and location of the window insets through a menu interface. Eight monitors can be accommodated, each focusing on different airport areas. An image trail feature is also available that indicates the velocity of targets.

Periodic testing of all ASDE-3 components is done automatically. Each subsystem, except the antenna, has a redundant backup that is automatically selected in the event of equipment failure.

Requirement	Value
COVERAGE <ul style="list-style-type: none"> • Minimum Range • Maximum Range • Altitude 	500 feet 24,000 feet Ground to 200 feet above airport surface
RESOLUTION AND ACCURACY <ul style="list-style-type: none"> • Azimuth Resolution • Range Resolution • Range Accuracy 	Distinguish 2 targets 80 feet apart at 12,000 feet 40-foot separation Within 12 feet of actual position
DETECTION <ul style="list-style-type: none"> • Probability of Detection • Probability of False Alarm • Nominal Target Cross Section • Weather Conditions 	90% Less than 10 ⁻⁶ 3 square meters 16 mm/hour
DISPLAY <ul style="list-style-type: none"> • Unique Positions • Resolution • Size 	8 1024 by 1024 pixels 17-inch diagonal
ANTENNA <ul style="list-style-type: none"> • Location • Height 	Local: On ATC Tower Remote: Separate tower when required 50 feet minimum to 300 feet maximum
MISCELLANEOUS <ul style="list-style-type: none"> • Airport Map • System Availability • Maintenance Features • Extension Capability 	Absolute accuracy: 12 feet 99.8% Remote monitoring capability Accommodate two or more antenna system inputs

Table 1. ASDE-3 Requirements³

ACY was a test site for ASDE-3 originally. Over time, essential radar equipment was moved from ACY to other sites which made the ACY ASDE-3 nonoperational. Radar equipment was brought back to ACY in order to have an operational system for this demonstration. The FAA and Norden supplied equipment and support to provide a local ASDE-3 radar. Since this was not a fully commissioned system, detailed calibration was not completed prior to this demonstration. This resulted in anomalies, which may have been avoided had full calibration of the system occurred.

AMASS -- The Airport Movement Area Safety System (AMASS) is a ground traffic control advisor system to help controllers manage traffic on airport surfaces. AMASS was developed by Westinghouse Norden Systems under FAA sponsorship [4][5] and will ultimately be installed at all ASDE-3 sites.

AMASS analyzes airport surface vehicle movements for situations that can lead to potential incursions on runways and at taxiway intersections. The system accepts input once a second from the ASDE-3 radar and the Automated Radar Terminal System (ARTS) as shown in figure 5. The ASDE-3 provides a track file for all targets (aircraft, ground vehicles, and any debris located on active surfaces) that includes the present and predicted position, velocity, size, heading, etc. ARTS provides data on approaching aircraft that are being monitored by the Airport Surveillance Radar (ASR). ARTS data can include position, velocity, altitude, flight number, and the landing runway

³ Summarized from [3].

number. AMASS correlates the ASDE-3 and ARTS targets and performs safety logic processing once a second that detects and identifies nearly 1000 potentially hazardous situations. If a hazard exists, AMASS issues audible alerts and displays visual warnings on the existing ASDE-3 display monitors. The visual warning information can include blinking symbols to identify targets that may cause potential incursions or hold bars in front of aircraft and/or at runway intersections.

AMASS requires no additional aircraft equipment and can be installed at airports with minimum impact on operations since equipment is added in the control tower, not on airport surfaces. The modular design of AMASS will enable future enhancements and additional sensors.

A research and development version of AMASS, which was interfaced strictly to the ASDE-3, was used for this flight demonstration.

Differential Global Positioning System -- The Global Positioning System (GPS) [6] is a satellite based radio navigation system designed to provide continuous all-weather navigation on a world wide basis. It consists of the space segment, the control segment, and the user segment. The space segment consists of 24 satellites circling the earth in six orbits, with four satellites in each. These satellites continuously transmit a ranging signal that includes the satellites current position and time correction. The Air Force Space Command established initial operational capability in December 1993 when all 24 GPS satellites became operational. The FAA then declared GPS operational for aviation use in February 1994. The control segment began operating in 1985 and consists of five monitor stations, four ground antenna upload stations, and the Operational Control Center. The objectives of the control segment are to track the GPS satellites, monitor their status, and maintain their orbit and clocks. The user, both civil and military, must utilize a receiver to track the ranging signals from selected satellites and calculate three-dimensional position and local time. Measurements must be made on four or more satellites simultaneously to obtain real-time three-dimensional navigation. The navigation performance of GPS is affected by satellite geometry and a variety of ranging errors.

One method of improving the accuracy and integrity of GPS is through a technique known as differential GPS (DGPS). The most common method of DGPS is known as local area DGPS (fig. 6). Here, a single reference receiver is located at a known surveyed position. The reference receiver estimates the range measurement error of each satellite in view and creates a correction for each satellite. The correction is broadcast to each DGPS user via some form of communication link. With DGPS, positioning accuracy can be increased to better than 1 meter, provided the correction is received within 10 seconds and the user is within 50 km of the reference receiver.

For this flight demonstration, DGPS was used to determine the location of the TSRV. An Ashtech Z-12 GPS receiver was located onboard the aircraft. This receiver was updated once a second with differential corrections generated by an ARINC provided NovAtel GPS receiver located at the ground station. The corrections were formatted according to RTCA DO-217 specifications [7]. This differentially corrected position information was blended with position data from the TSRV's Inertial Reference System (IRS) and then used to display the location of the TSRV at 20 Hz on an electronic moving map located onboard the aircraft.

Another NovAtel GPS receiver, provided by ARINC, was located onboard the TSRV. This position data was also differentially corrected and then transmitted to the ground station once a second in the form of a high precision Automatic Dependent Surveillance (ADS) message [8]. The ADS message was delivered, in ARINC 622 format [9], to the AMASS to use to correlate an identification tag to the TSRV ASDE-3 radar track for display on the test controller's AMASS display.

GPS data was recorded within the NASA Ashtech receiver onboard the aircraft as well as within an additional Ashtech receiver located at the ground station. This data was used during post test analysis

to determine the “true” position of the TSRV using a precision navigation software package. This software provided centimeter level accurate position data.

Data Link -- The ability to rapidly transmit data among various airport systems and aircraft is essential for integrated airport surface operations. Various protocols, which fall under the category of aeronautical data links, exist to perform data transfer. Two possible types of data link are Very High Frequency (VHF) and Mode-S. The VHF data link utilizes data radios that operate in the VHF communications band of 118 - 137 MHz. The Mode-S link transmits uplink messages at 1030 MHz and downlink messages at 1090 MHz. These fixed channels are shared among all users. The current use for Mode-S is for surveillance of aircraft equipped with Mode-A/C/S transponders, however, Mode-S is also capable of broadcast and addressed data link communications.

A study was conducted for integrated surface operations [10]. The study made data link recommendations for various surface operations communications as summarized in table 2.

Data Link Service	Recommended Data Link
ADS Broadcast	MODE-S
DGPS	VHF (DO-217, APPENDIX F [7])
Time critical controller pilot data link comm.	MODE-S
Cockpit display of traffic information	VHF
Non-time critical controller pilot data link comm.	VHF Data Radio (ARINC 750[11])

Table 2. Data Link Recommendations for Integrated Surface Operations.

For this demonstration, a single high speed bi-directional VHF data link [11] [12] was used to transmit data at 31.5 KBPS between the TSRV and ground station. This single link transmitted all data required. Programmable E-Systems VHF data radios (VDR) were utilized. These VDRs utilized the D8PSK format. Modifications were made to the radios to set the serial port baud rate at 19.2 KBPS and extend the frequency band range to 108.000 through 136.975 MHz. The VDRs used the Aviation VHF Packet Communications (AVPAC) protocol [12] [13]. AVPAC is a protocol stack for exchanging bit oriented data across an air-ground VHF data link. This was the first demonstration of the new high speed VHF Digital Link (VDL) waveform as defined in section 2 of [14]. Reference 15 gives a detailed description of the data link implementation for this demonstration.

Ground Station Architecture -- The flight demonstration ground station was developed by ARINC, Inc. The architecture for the ground station is shown in figure 7. The ground station, an IBM RS-6000 computer, managed all data communications between the demonstration subsystems. The station would receive data from the AMASS (ASDE-3 traffic positions and runway hold bars), DGPS reference receiver (position corrections), and the controller workstation (taxi clearances and hold short commands); format this data; and route it to the TSRV aircraft via the VHF data link. ADS messages were received from the aircraft, formatted into ARINC 622 format [9], and transmitted to AMASS to identify the TSRV position for identification tagging. Pilot acknowledgment of controller instructions were also downlinked from the TSRV, formatted, and displayed on the controller workstation. The ground station also recorded the data packets as sent across the data link for post analysis. Reference 16 contains the ground station to AMASS interface specification used for this demonstration. A detailed description of the ground station can be found in reference 15.

Controller Workstation Interface -- A controller workstation interface was developed to enable a test controller to send taxi routes, modifications to assigned taxi routes, hold short instructions, and clearances via a VHF data link to the TSRV for display on the electronic map. A menu driven interface was chosen in order to emulate existing controller interfaces used in actual airport control towers.

For this demonstration, the workstation was developed by ARINC. Inc. The workstation was implemented on a personal computer which was interfaced to the ground station via an RS-232 interface. All software to drive the workstation was housed in the ground station computer.

Electronic Moving Map -- An electronic moving map for the aircraft (fig. 8) was developed and evaluated in simulator studies [17] at NASA LaRC. For the demonstration, the map was generated by a Silicon Graphics Personal Iris workstation and displayed on a liquid crystal flat panel that had a 640 by 480 pixel resolution and display dimensions of 8.5 inches by 6.5 inches (fig. 9). The pilot interacted with the moving map through bezel switches located on each side of the display. The available functions included acknowledging the taxi route, acknowledging hold short commands, zoom in/out, show/hide other traffic, show/hide five second position prediction indicator, track/north up mode, display an insert containing the airport, and Air Traffic Control (ATC) message recall. Additionally, the map could be set to show navigational aids within a 25 mile radius of the airport.

Figure 8 shows the major components of the moving map. The aircraft locator symbol was updated at 20 HZ from a blending of the DGPS position and inertial data from the TSRV's IRS.

Warning information that indicated occupied runways (AMASS hold bars) and positions of other traffic were transmitted to the TSRV via data link automatically from the ground system for display on the moving map.

The cleared taxi route, modified routes, and hold short clearances were sent to the TSRV by a test ground controller from the controller workstation via data link. For this demonstration, the routes and modified routes were scripted for each run.

Demonstration Description

During a demonstration session, the TSRV followed a departure and arrival taxi route that included a real-time modification to the route (fig. 10). The old ACY control tower housed all ground equipment and was the base of operation for the test ground controller (fig. 11). The FAA Technical Center mounted three cameras on the ASDE-3 radar tower. These images were displayed at the ground site so the test controller could view the airport since the movement area was not visible from that location. Demonstrations were given for government and industry representatives.

At all times during the demonstration, the TSRV was under ACY air traffic control. The safety pilot in the forward flight deck was in contact with the control tower. The test controller monitored ACY control to determine what information to transmit to the aircraft through the menu driven interface. The test controller communicated with the research pilot in the research flight deck on the TSRV strictly by data link and with the researchers on the TSRV by voice. The research pilot was not monitoring the tower. To lessen the burden on the tower, ACY asked that the safety pilot request the desired route and holds before each run. The tower then repeated the command. At that point, the test controller sent the appropriate route and hold short information to the TSRV for acknowledgment by the research pilot. When a modification to the route was desired, the safety pilot requested the desired change while holding or when taxiing along the route, the tower then broadcast the command, and the test controller sent the route change to the TSRV. On departure, the route request was made at the gate (which was the FAA ramp in this case). Upon arrival, the request was made after exit from the runway.

Additionally, the identification of the TSRV was shown on the test controller's AMASS display next to the aircraft's symbol. AMASS used the ADS position report to fuse the identification with the appropriate ASDE-3 radar track.

For the flight demonstration, the electronic moving map was located in the research flight deck of the TSRV (fig. 12). The safety pilot in the forward flight deck was controlling the aircraft during taxi because the research flight deck did not have a steering tiller. At all times, the safety pilot was to taxi the aircraft on the centerlines. The research pilot verbally relayed routing and situation information obtained from the electronic map to the safety pilot. The situation information included status of the TSRV on the taxi route (when turns were approaching, etc.), when holds were approaching, and the location of relevant traffic. Since the aircraft was taxied on centerline, the research pilot could determine any anomalies in the electronic map by viewing how well the aircraft symbol followed the centerlines.

A video link was established between the TSRV and the ground site. This enabled the test controller and visitors to selectively view the electronic map image, tail camera image, or research flight deck in real-time.

RESULTS

Although these flight trials were primarily aimed at demonstrating the feasibility of integrating several advanced technologies, they also provided an opportunity to gather qualitative and quantitative real-time data. Analysis of this data has revealed characteristics about the performance of each technology individually and the system as a whole.

Data Collection

During each flight (taxi out, takeoff acceleration, landing deceleration, taxi in), data was recorded in three locations: (1) at the ASDE/AMASS site; (2) at the ground station; and (3) onboard the TSRV. All data was time-stamped to allow for synchronization and analysis after the flights.

Data recorded at the ASDE/AMASS site included all ASDE/AMASS data sent to the ground station (e.g. traffic positions and AMASS hold bars), as well as the data received from the ground station (e.g. ADS messages downlinked from the aircraft). This data was recorded at 1 Hz.

Data recorded at the ground station included messages sent to and received from the aircraft (e.g. DGPS corrections, ADS messages, controller instructions, and ASDE/AMASS data). This data was also recorded at 1 Hz.

Data was stored onboard the TSRV in three locations. GPS-related information (e.g. satellites tracked, GPS time, latitude/longitude, DGPS corrections, etc.) was stored in the GPS receiver at 1 Hz. The data acquisition system on the TSRV recorded 80 aircraft state variables at 20 Hz (e.g. ground speed, yaw rate, nosewheel position, braking force, etc.) and also all the data received across the data link. Five video tapes were recorded during each flight. These videos were recorded from a tail camera, a nose camera, the electronic map display, the rear flight deck cockpit, and the flight instruments. An audio tape was made of the conversations between the safety and research pilots; the safety pilots and the control tower; the research pilot and the researchers; and the researchers and the test controller. Lastly, subjective comments were obtained from the pilots, controllers, and visitors on the effectiveness, content and operation of each subsystem.

Quantitative Results

The analysis was focused on data accuracy, availability, and integrity. Accuracy ensures that all target positions, including the TSRV, are correct with respect to their true position on the airport surface. Availability is important in an operational environment because information must be received in a timely manner both onboard the aircraft and by the controller. Integrity ensures that the data received has not been corrupted as it moves along its path.

Accuracy

Table 3 lists the position accuracies obtained during testing on June 27 and June 28, 1995. The “true” position of the TSRV at all times was calculated using precision navigation software. This software can process GPS data during post flight to determine position within five centimeters.

The raw ASDE-3 track data received onboard appeared to be slightly skewed from its location on the ASDE-3 display. The cause of this apparent skew is unknown; however, it may have resulted from the process of converting the ASDE’s polar coordinate system (range, azimuth) to the TSRV’s WGS-84 coordinate system (latitude, longitude). A rotation of 0.01 radians was added (during post-processing) to the radar data received on the TSRV to minimize this skew. Time permitting, this could have easily been done during testing at the ASDE site to eliminate this skew in real-time.

The position accuracy data reveals that both sensors can be used to support a surface surveillance function (i.e. allow pilots to observe relative locations of other traffic on the airport surface). The requirement for position accuracy for a surveillance system on the airport surface has been defined in [18] to be 10m.

Requirements for position accuracy to support surface guidance and navigation functions are listed in [19]. In [19], 2m is suggested as adequate. The data collected suggests that the DGPS system used here is adequate to support the guidance and navigation function with respect to position accuracy.

Run	DGPS		ASDE-3	
	Mean	Std Dev	Mean	Std Dev
6/27 #1	1.428’	0.872’	18.870’	12.450’
6/27 #2	0.981’	0.758’	19.271’	12.250’
6/27 #3	1.071’	0.710’	27.610’	18.919’
6/27 #4	2.124’	1.060’	24.630’	15.694’
6/27 #5	1.853’	0.680’	42.483’	33.221’
6/27 #6	2.468’	1.018’	30.134’	22.845’
6/27 #7	2.175’	0.860’	24.171’	16.207’
6/28 #1	2.320’	3.175’	45.177’	27.329’
6/28 #2	2.122’	1.175’	27.366’	13.451’
6/28 #3	2.400’	1.030’	20.680’	13.596’
6/28 #4	1.880’	1.070’	27.740’	15.912’
Overall	1.893’	1.128’	28.012’	18.352’

Table 3. Position sensor accuracies for 6/27 and 6/28.

Availability

Uplinked data consisted of the controller instructions, AMASS hold bars, DGPS corrections, and traffic positions. Instructions from the test ground controller were always received in a timely manner by the test pilot monitoring the cockpit map display. These instructions included the taxi route, hold short instructions, and clearances to proceed. Delays in issuing commands would sometimes occur due to unfamiliarity with the user interface at the controller workstation. However, once a command was issued, its appearance on the cockpit display was nearly immediate. Future work should address developing a more user-friendly controller interface.

To validate the uplink of AMASS hold bars, the TSRV performed a high-speed taxi while on the runway surface. By performing a takeoff abort in this fashion, the AMASS hold bar function would be activated. In the 11 runs where this was attempted, the AMASS hold bars were illuminated on the

cockpit display 10 times. In each of these occurrences, the bars appeared and disappeared appropriately with respect to the TSRV's location on the runway. The one occurrence when the hold bars did not illuminate suggested that the TSRV did not achieve the necessary acceleration and velocity to be deemed a takeoff (or landing) by the AMASS software.

The DGPS system was designed such that DGPS corrections would be received onboard the TSRV every second (at 1Hz). However, there were brief periods during the testing when the delay slipped to as large as 15 seconds. This was primarily due to inefficiencies within the data radio being used. Despite the occasional delay in receiving a correction, the DGPS solution was maintained to within one meter (see table 3) by the DGPS/INS blending function. This function returned a position that would slowly drift from the true position until another DGPS update was received. Because the aircraft was moving slowly on the surface while taxiing, an accurate position could be maintained without frequent updates from the DGPS system. Based on this testing, it is apparent that an update rate of 3-15 seconds would be sufficient for DGPS corrections while taxiing on an airport surface. The exact update rate that would be sufficient to maintain accurate DGPS is unknown and should be the subject of future work.

The availability of the ASDE-3 traffic data (i.e. target positions for a complete scan of the airport surface) onboard the TSRV is represented in figure 13. For these tests, traffic data was received every second 55% of the time. Similarly, traffic data was received within two seconds about 75% of the time. Finally, if five second delays can be tolerated in receiving traffic data, it will be available 90% of the time. Future studies should address how much delay can be tolerated in receiving traffic data.

Integrity

Less than 1% of the messages received onboard the TSRV were observed to be corrupted (and these were due to format errors⁴). However, one integrity issue observed was the intermittent disappearance of target tracks onboard the aircraft for short periods of time during specific runs.

Vehicle ID	ASDE-3			TSRV			%Received
	points	time (sec)	rate (sec/pt)	points	time (sec)	rate (sec/pt)	
TSRV	462	658	1.42	302	657	2.17	65.4
4260048	202	202	1.00	127	200	1.57	62.9
4260107	111	111	1.00	96	111	1.41	86.5
4260192	6	6	1.00	3	4	1.33	50.0
4260063	6	6	1.00	0	0	NA	0.0
Overall	787	983	1.25	528	996	1.89	71.6

Table 4. Target track data (6/28 Run 4).

Table 4 depicts target track data recorded at the radar site and onboard the TSRV respectively for a run performed on June 28, 1995. Note that vehicle 4260048 was tracked for 202 seconds by ASDE-3; however, the TSRV received only 127 position updates during this time. It is not clear what caused these types of drop outs; however, it bears directly on the target availability issue described above. It is suspected that the cause is related to the method chosen to package data and/or the priorities assigned to the various message types prior to uplink.

⁴ Format errors resulted from incorrect packaging of data at the transmit site.

In table 4, vehicles 4260063 and 4260192 are “ghost” targets (i.e. not real targets). These are general radar disturbances caused by multipath signals received by the ASDE-3. Future work should address developing techniques to eliminate tracking “ghost” targets

Qualitative Results

During the course of the flight trials, subjective comments were obtained from pilots, controllers, and visitors on the effectiveness, content, and operation of each subsystem.

Pilot Comments

A NASA pilot served as the research pilot in the RFD and operated the electronic map display. The research pilot stated an electronic map of the airport in the cockpit would be beneficial. Several comments were given relative to the operation of the electronic map itself. Useful features were the location of the subject aircraft depicted on the map, taxiway names, trend vector, hold bars, positions of other traffic, and datalinked ATC commands. The zoom feature could be enhanced. In order to maintain an overall acceptable level of situational awareness, too many map scale changes were required. The closest zoom level was good for providing tactical situational awareness information such as where the aircraft was in relation to the centerline but did not provide any global situational awareness. The airport inset provided some global information; however, the scale was not controllable. At the lower zoom levels, the map provided much improved strategic situational awareness but at the sacrifice of tactical situational awareness.

The research pilot stated that in actual operations it would take two people to utilize the map effectively. The captain may use the map at the higher zoom levels for tactical situational awareness while the first officer would use the map at a lower zoom level for global situational awareness. The research pilot commented that although it may be technically possible to taxi an aircraft by using the map exclusively, the crew would not want to be heads down while the aircraft is moving. A HUD would be more useful for providing guidance information. The research pilot also indicated that the map should be located on the primary navigation display. This would lead to a natural transition from inflight symbology to taxi symbology and vice versa.

The research pilot also stated that before the pilots of any aircraft would use an electronic map, such as the one demonstrated, to taxi an aircraft in severely limited visibility conditions, a large measure of confidence would be needed in the information being presented. This includes the accuracy, timeliness, and validity of the database of the airport, position of the subject aircraft, position of other traffic on the airport, and ATC commands.

Comments were also obtained from four of the visitors who were pilots. In general, the visitor pilots believed that the demonstration system would be valuable for situational awareness, during taxi, and could help improve safety, capacity, and efficiency during both low visibility and clear weather conditions. These pilots commented that both crew members should have access to the map display and that the use of an electronic map could also reduce pilot workload and stress.

Controller Comments

Comments on the integrated surface operations system were obtained from the two former controllers that participated as test controllers for the demonstration. Comments were also obtained from two of the visitors who were former controllers.

The controllers stated that the integrated system would be extremely beneficial during night time operations and for low visibility conditions. They particularly thought the cockpit display of traffic

information would be useful. A controller commented that this type of system would be overkill for smaller airports.

All agreed that the menu driven interface of the controller workstation was cumbersome and would add workload to the controller. The controller should spend a high percentage of his/her time viewing airport traffic out the window and not looking down to find a particular button to press. The controllers suggested that the system be voice activated to minimize workload impact.

Visitor Comments

Demonstrations of the integrated airport surface operations system were conducted for government and industry representatives on June 27 - 29, 1995. Thirty two visitors attended the demonstrations. Each visitor was asked to complete a questionnaire at the conclusion of the demonstration, giving his/her opinion on the potential benefits of the demonstrated technologies in terms of improving safety, increasing capacity/efficiency, and reducing operating costs relative to the National Airspace System. The questionnaire is shown in Appendix B. Twenty six visitors responded to the questionnaire.

Figures 14 - 16 show the questionnaire responses in graph form. An overwhelming number of visitors (92%) indicated that the demonstration technologies would be beneficial in improving safety on the airport surface, particularly an electronic map display of the airport and the use of DGPS for aircraft positioning (fig. 14). There was also strong agreement among the visitors that the subject technologies could increase the capacity and efficiency at airports (fig. 15). Most visitors agreed that the demonstration technologies would reduce costs associated with airport/airline operations (fig. 16) even though cost data was not available.

CONCLUDING REMARKS

The flight trials successfully demonstrated an integration of technologies that provided the pilot and controller with situation awareness information that may enable safe increases in traffic capacity on the airport surface. Analysis shows that both DGPS and ASDE-3 position data can be used to support surface surveillance (i.e. pilot observation of relative locations of airport traffic); however, only the DGPS sensor was shown to be adequate (within 2m) for surface navigation and guidance with respect to position accuracy. Uplink datalink delays of traffic position were within 5 seconds 90% of the time. Further study is required to determine safe delay tolerances. Less than 1% of uplink messages were observed to be corrupted. However, work is needed to eliminate datalink drop outs in receiving airport traffic data onboard and the tracking of "ghost" targets (multipath). Pilot comments obtained during the testing indicated the electronic map would be beneficial for situational awareness, particularly depicting the location of the subject aircraft and other traffic on the airport, ATC instructions (hold bars and taxi route), and labeling of airport taxiways and runways. The controllers involved in the testing indicated the integrated system would be extremely beneficial during night time and low visibility conditions. However, all controllers agreed that the controller workstation interface should be voice activated rather than menu driven. In general, the visitors attending the demonstrations agreed that the flight test system has the potential to improve safety and increase the capacity and efficiency on the airport surface. The results from this test will be used as drivers (or lessons learned) for subsequent flight testing that will occur over the next several years as part of NASA's TAP LVLASO research program.

REFERENCES

- [1] DOT/FAA: 1995 Federal Aviation Administration Plan for Research, Engineering, and Development. December, 1994.
- [2] White, John J.: Advanced Transport Operating Systems Program. Proceedings of the Aerospace Technology Conference and Exposition, October, 1990.
- [3] Go, George; and Ianniello, Joseph W.: Third Generation Airport Surface Detection Equipment Design. Proceedings of NAECON '94, May, 1994.
- [4] Watnick, Marshall; and Ianniello, Joseph W.: Airport Movement Area Safety System. Proceedings of the 11th Digital Avionics Systems Conference, October, 1992.
- [5] Ianniello, Joseph W.; and Kruczek, Raymond M.: Airport Surface Collision Warning System Implementation. Proceedings of the 12th Digital Avionics Systems Conference, October, 1993.
- [6] Global Positioning System: Theory and Applications, Vols. 1 and 2, American Institute of Aeronautics and Astronautics, Inc., 1996.
- [7] RTCA, Minimum Aviation System Performance Standards, DGNSS Instrument Approach System: Special Category I (SCAT-I), Document No. RTCA/DO-217, August 27, 1993.
- [8] Automatic Dependent Surveillance, ARINC Characteristic 745-2, June 30, 1993.
- [9] Non-user Specific Data Link Applications, ARINC Project Paper 622, June 3, 1992.
- [10] Doty, J. H.; Koczo, S.; Zimmerman, S. L.: Integrated Airport Surface Operations, Rockwell Collins Avionics, Inc., contract NAS1-19704-Task 13, April, 1996.
- [11] VHF Data Radio, ARINC Project Paper 750, Draft 2, July 1, 1992.
- [12] Aviation VHF Packet Communications (AVPAC) Functional Description. ARINC Specification 631-1, January 22, 1993, including Draft 2, Supplement 2, September 16, 1994.
- [13] Turner, Wendell: Use of Formal Description Techniques in Development and Implementation of AVPAC Protocol. Proceedings of the 14th Digital Avionics Systems Conference, November, 1995.
- [14] ICAO Standards and Recommended Practices (SARPS), Version 1.3, February, 1995.
- [15] ARINC, Final Report - NASA Terminal Area Productivity (TAP) Development. Prepared for Research Triangle Institute under contract RTI95/19-18U-4903, January, 1996.
- [16] Hambly, R. M.; Rajcsok, V.; and Asher, G. B.: End-To-End Data Communications Requirements to Support GNSS-Based Services Using ACARS, ARINC Inc., February 25, 1994.
- [17] Batson, Vernon M.; Harris, Randall L.; and Hunt, Patricia J.: Navigating the Airport Surface: Electronic vs Paper Maps. Proceedings of the 13th Digital Avionics Systems Conference, October, 1994.

[18] International Civil Aviation Organization (ICAO) All Weather Operations Panel (AWOP) A-SMGCS Subgroup: Draft Manual of Advanced Surface Movement Guidance and Control Systems (A-SMGCS). Draft 3. February, 1997.

[19] Cassell, R. and Smith, A.: Development of Required Navigation Performance Requirements for Airport Surface Movement Guidance and Control. Proceedings of the 14th Digital Avionics Systems Conference, November, 1995.

Appendix A

Commonly used acronyms.

ACY	Atlantic City International Airport
ADS	Automatic Dependent Surveillance
AMASS	Airport Movement Area Safety System
ASDE-3	Airport Surface Detection Equipment Radar
ATC	Air Traffic Control
DGPS	Differential Global Positioning System
FAA	Federal Aviation Administration
GPS	Global Positioning System
IRS	Inertial Reference System
LaRC	Langley Research Center
LVLASO	Low Visibility Landing and Surface Operations
NASA	National Aeronautics and Space Administration
RF	Radio Frequency
RFD	Research Flight Deck
SA	Selective Availability
TAP	Terminal Area Productivity
TSRV	Transport Systems Research Vehicle
VDR	VHF Data Radio
VHF	Very High Frequency

Appendix B

VISITOR'S QUESTIONNAIRE

These technologies would greatly benefit The NATIONAL AIRSPACE SYSTEM (NAS):

	IMPROVE SAFETY					INCREASE CAPACITY/EFFICIENCY					REDUCE COSTS				
	STRONGLY DISAGREE	DISAGREE	NO OPINION	AGREE	STRONGLY AGREE	STRONGLY DISAGREE	DISAGREE	NO OPINION	AGREE	STRONGLY AGREE	STRONGLY DISAGREE	DISAGREE	NO OPINION	AGREE	STRONGLY AGREE
ELECTRONIC MAP DISPLAY	<input type="checkbox"/>	<input type="checkbox"/>	<input type="checkbox"/>	<input type="checkbox"/>	<input type="checkbox"/>	<input type="checkbox"/>	<input type="checkbox"/>	<input type="checkbox"/>	<input type="checkbox"/>	<input type="checkbox"/>	<input type="checkbox"/>	<input type="checkbox"/>	<input type="checkbox"/>	<input type="checkbox"/>	<input type="checkbox"/>
DGPS/AIRCRAFT POSITIONING	<input type="checkbox"/>	<input type="checkbox"/>	<input type="checkbox"/>	<input type="checkbox"/>	<input type="checkbox"/>	<input type="checkbox"/>	<input type="checkbox"/>	<input type="checkbox"/>	<input type="checkbox"/>	<input type="checkbox"/>	<input type="checkbox"/>	<input type="checkbox"/>	<input type="checkbox"/>	<input type="checkbox"/>	<input type="checkbox"/>
DATA LINK OF TRAFFIC	<input type="checkbox"/>	<input type="checkbox"/>	<input type="checkbox"/>	<input type="checkbox"/>	<input type="checkbox"/>	<input type="checkbox"/>	<input type="checkbox"/>	<input type="checkbox"/>	<input type="checkbox"/>	<input type="checkbox"/>	<input type="checkbox"/>	<input type="checkbox"/>	<input type="checkbox"/>	<input type="checkbox"/>	<input type="checkbox"/>
DATA LINK DISPLAY OF CONTROLLER INFORMATION	<input type="checkbox"/>	<input type="checkbox"/>	<input type="checkbox"/>	<input type="checkbox"/>	<input type="checkbox"/>	<input type="checkbox"/>	<input type="checkbox"/>	<input type="checkbox"/>	<input type="checkbox"/>	<input type="checkbox"/>	<input type="checkbox"/>	<input type="checkbox"/>	<input type="checkbox"/>	<input type="checkbox"/>	<input type="checkbox"/>
TRANSPONDER/TAGGING ON AMASS DISPLAY	<input type="checkbox"/>	<input type="checkbox"/>	<input type="checkbox"/>	<input type="checkbox"/>	<input type="checkbox"/>	<input type="checkbox"/>	<input type="checkbox"/>	<input type="checkbox"/>	<input type="checkbox"/>	<input type="checkbox"/>	<input type="checkbox"/>	<input type="checkbox"/>	<input type="checkbox"/>	<input type="checkbox"/>	<input type="checkbox"/>
INTEGRATION OF ABOVE TECHNOLOGIES	<input type="checkbox"/>	<input type="checkbox"/>	<input type="checkbox"/>	<input type="checkbox"/>	<input type="checkbox"/>	<input type="checkbox"/>	<input type="checkbox"/>	<input type="checkbox"/>	<input type="checkbox"/>	<input type="checkbox"/>	<input type="checkbox"/>	<input type="checkbox"/>	<input type="checkbox"/>	<input type="checkbox"/>	<input type="checkbox"/>

Do you know of other technologies that would have better demonstrated these concepts? If so, what technology would you like to see in place of the technology demonstrated here?

Comments:

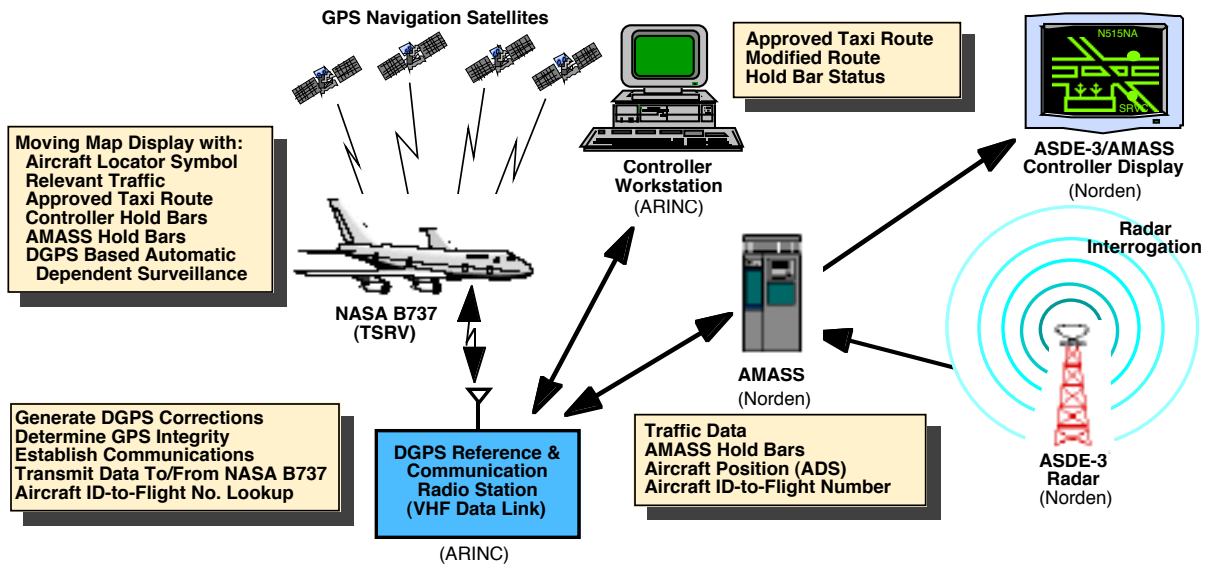

Figure 1. Flight demonstration schematic.

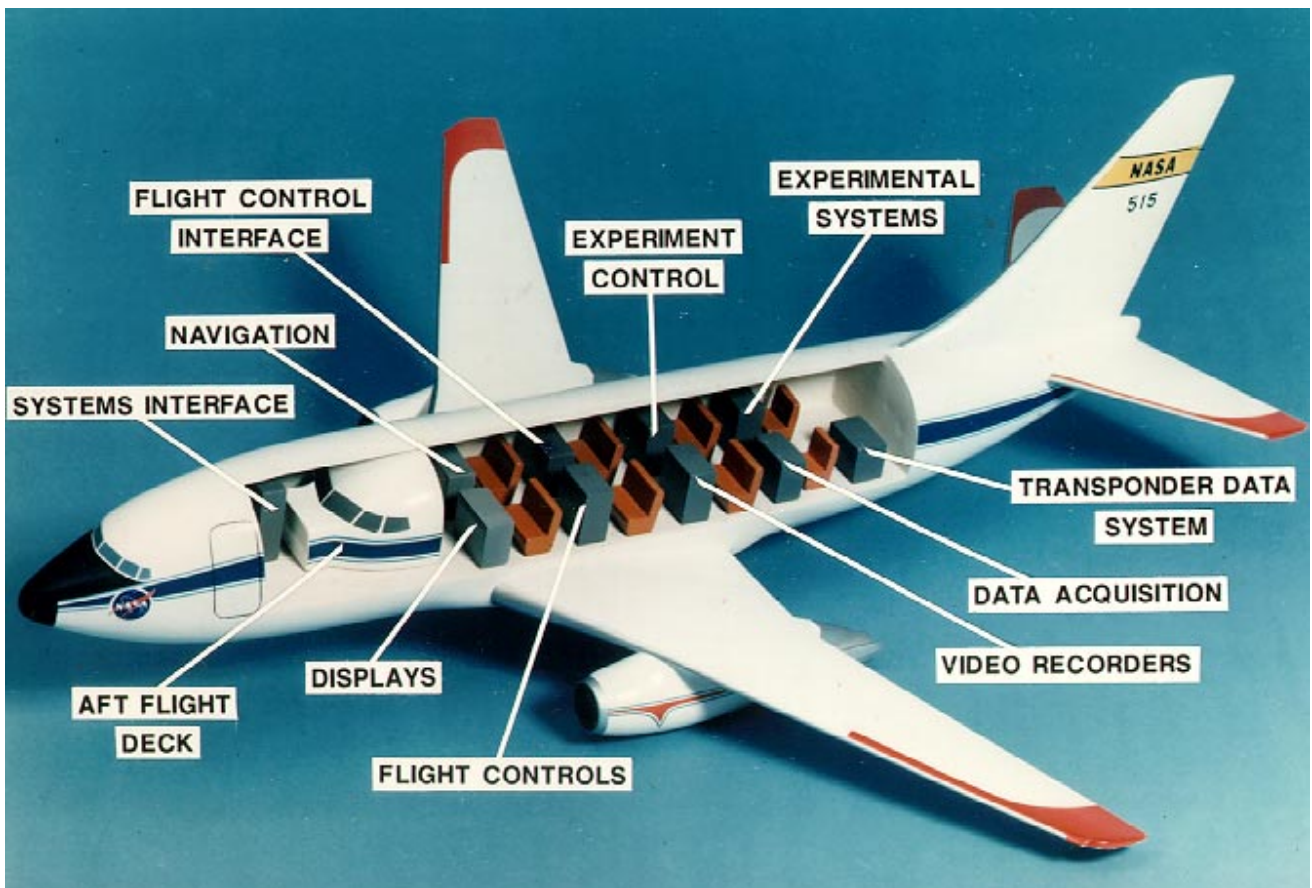

Figure 2. NASA Boeing 737 configuration.

L-85-10,992

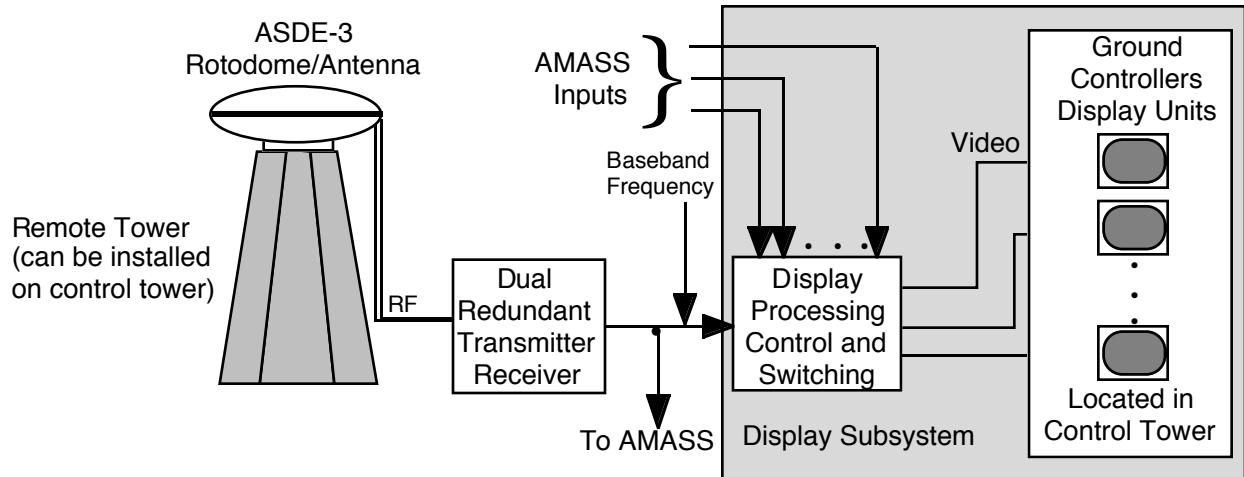

Figure 3. Simplified block diagram of the ASDE-3 system.



L-95-04475

Figure 4. ASDE-3 radome at ACY.

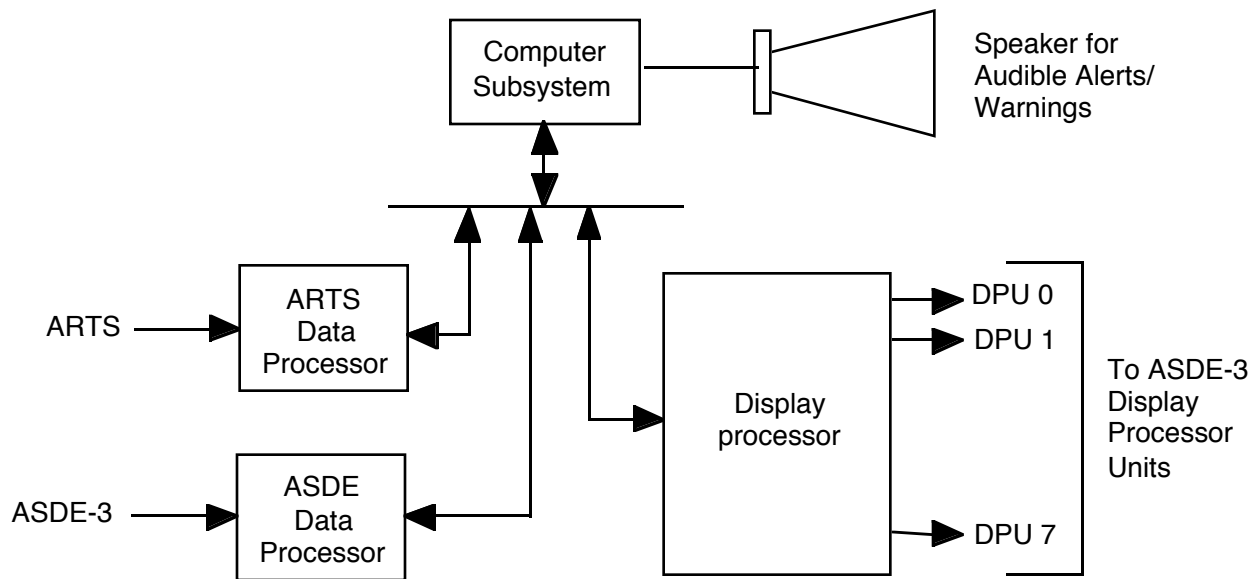

Figure 5. AMASS equipment block diagram.

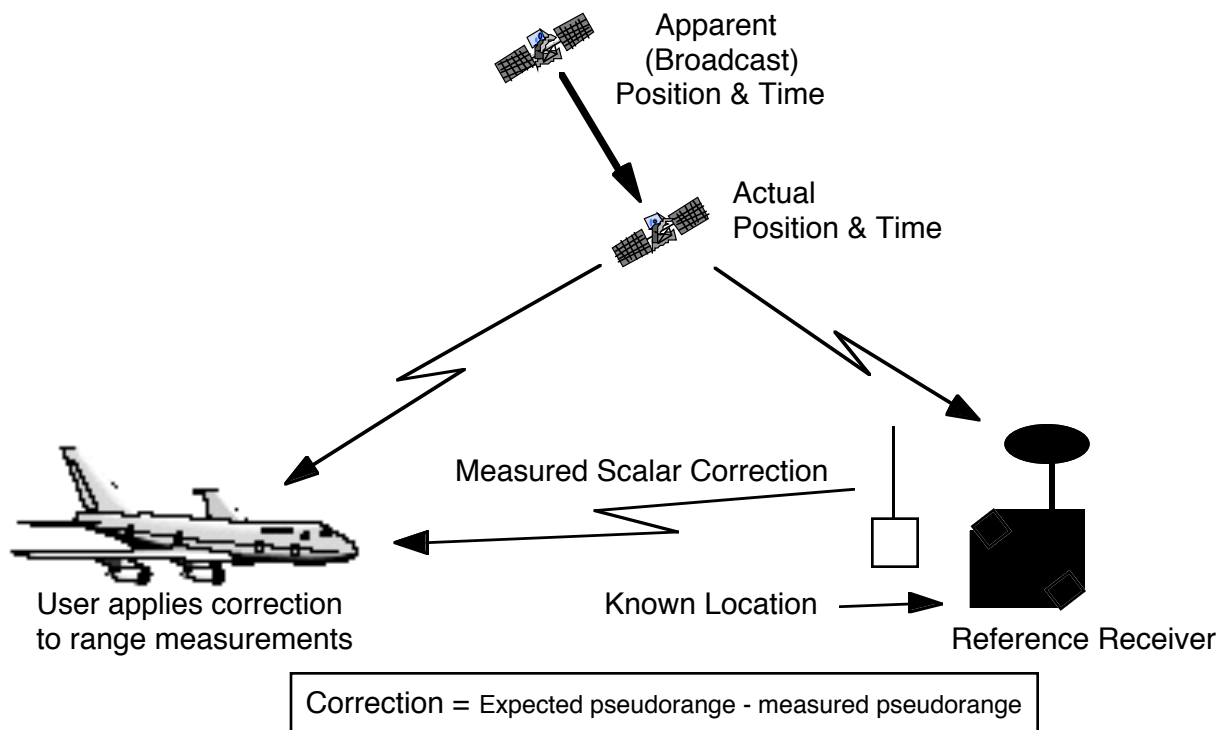

Figure 6. Local area differential GPS.

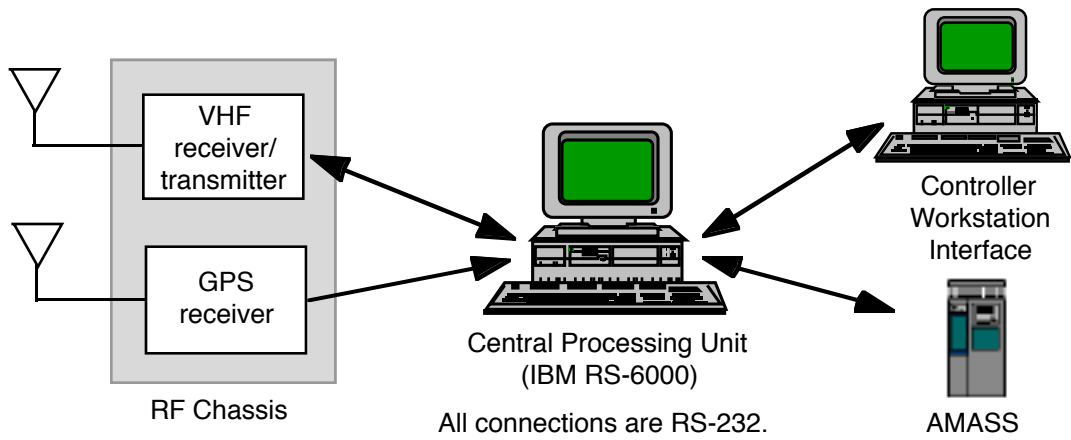

Figure 7. Ground station architecture.

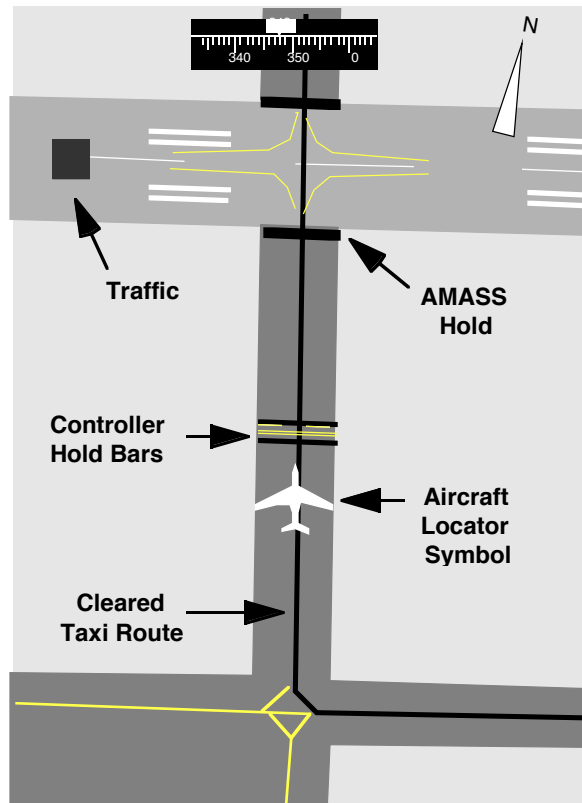
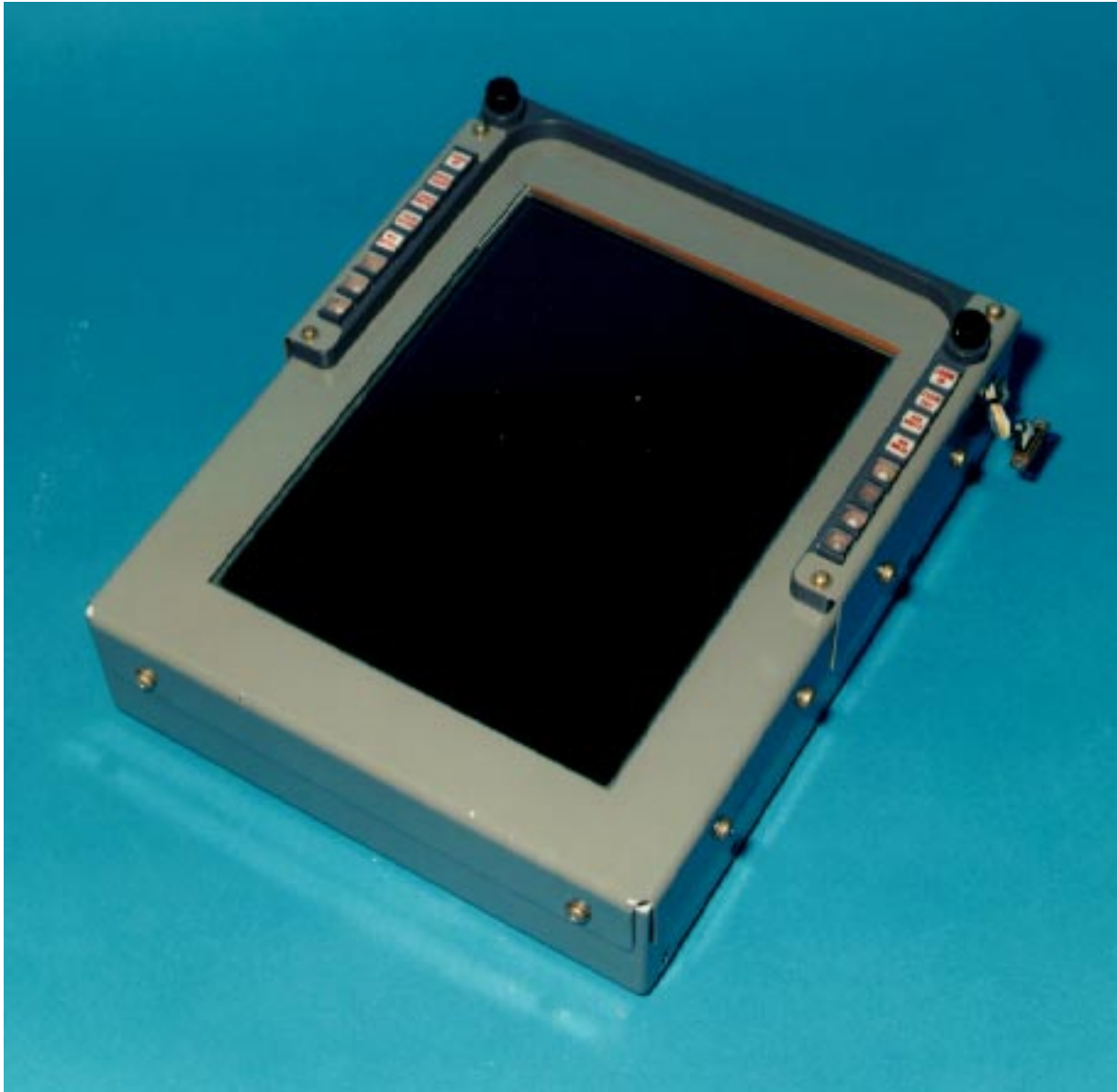
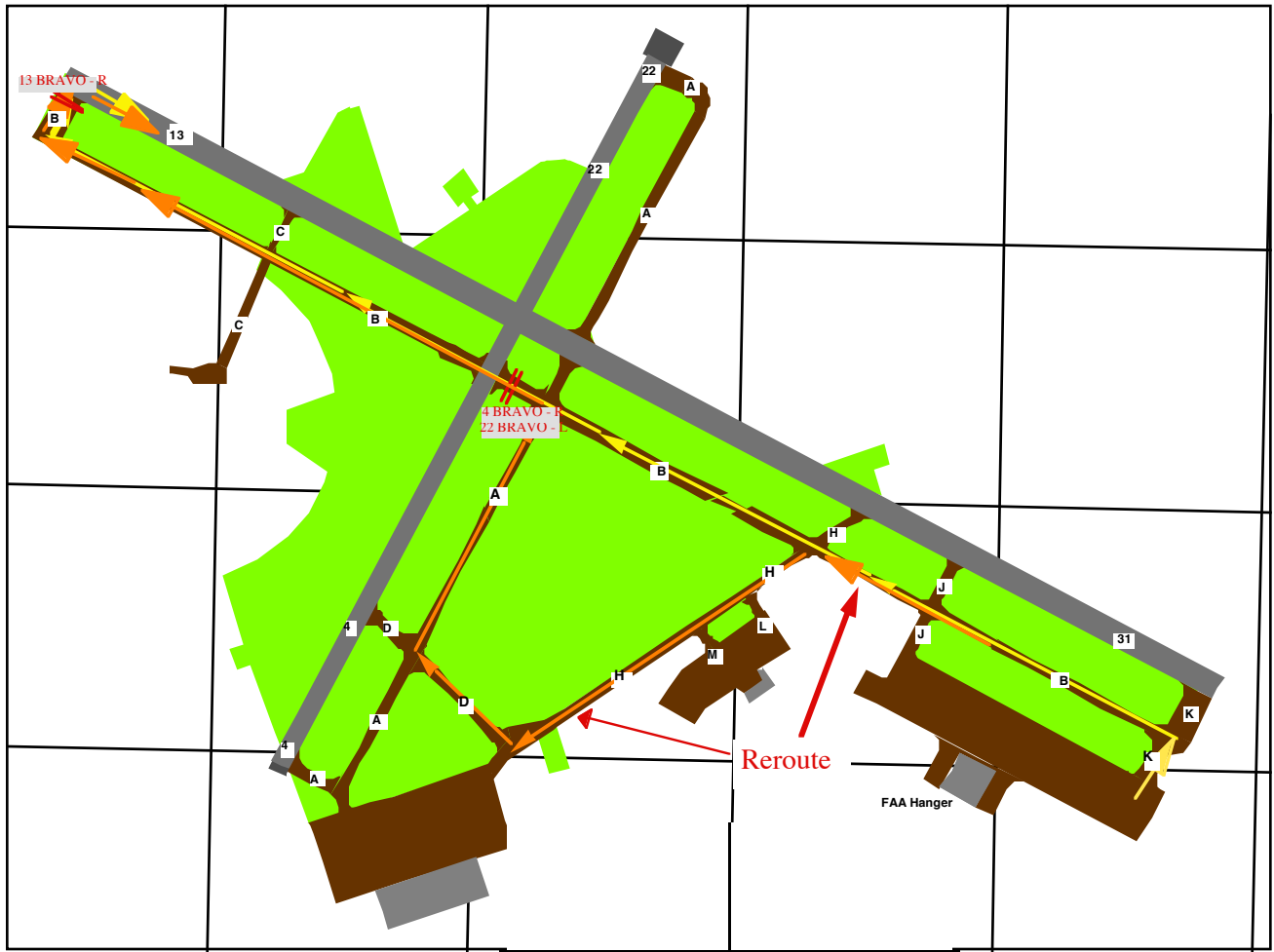

Figure 8. Electronic moving map display.



L-95-04527

Figure 9. Liquid crystal flat panel display with bezel switches.



* Letters denote taxiway names

Figure 10. Sample departure taxi route.



L-95-04472

Figure 11. Test equipment located at ground station.

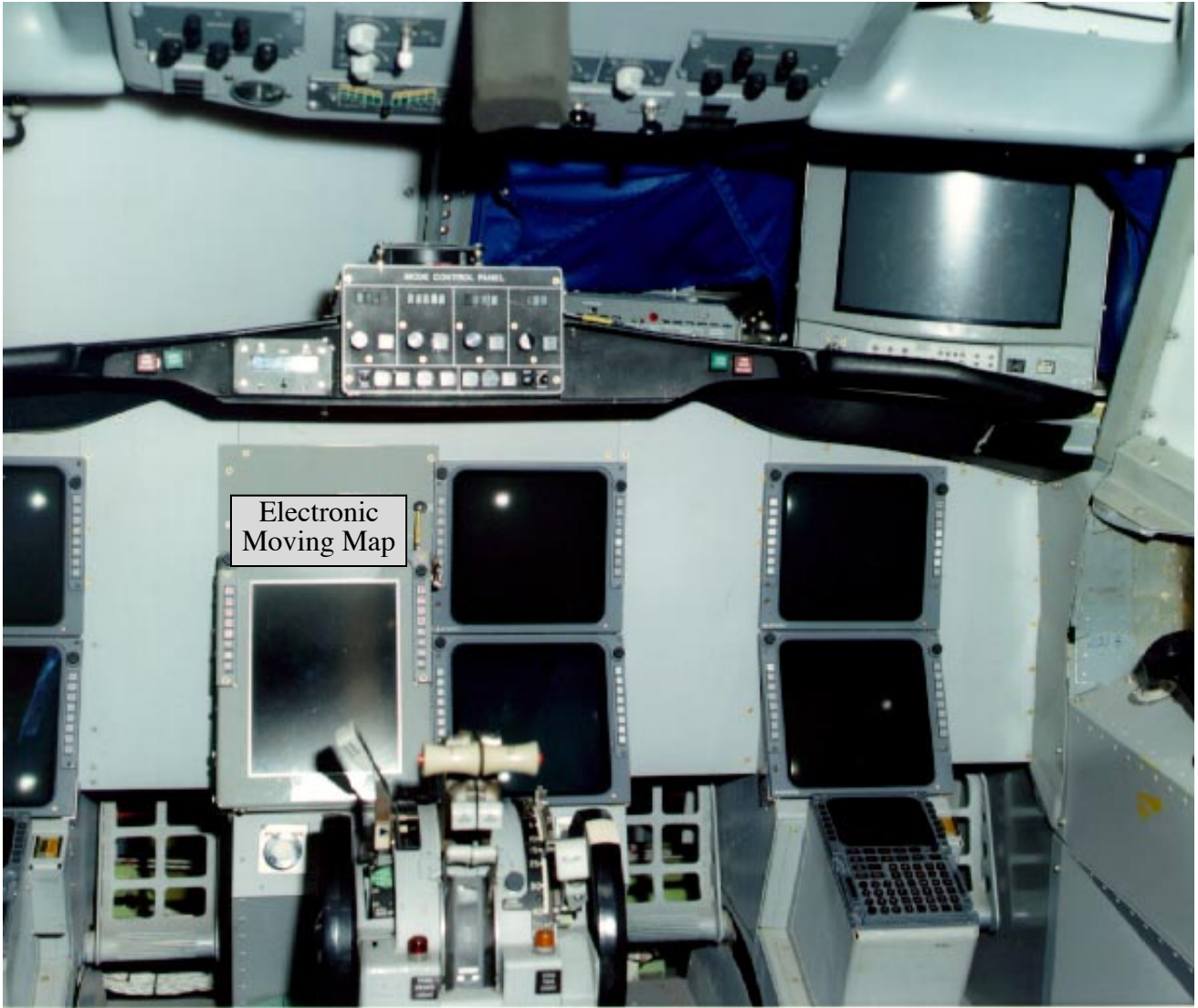

L-95-04127

Figure 12. TSRV research flight deck.

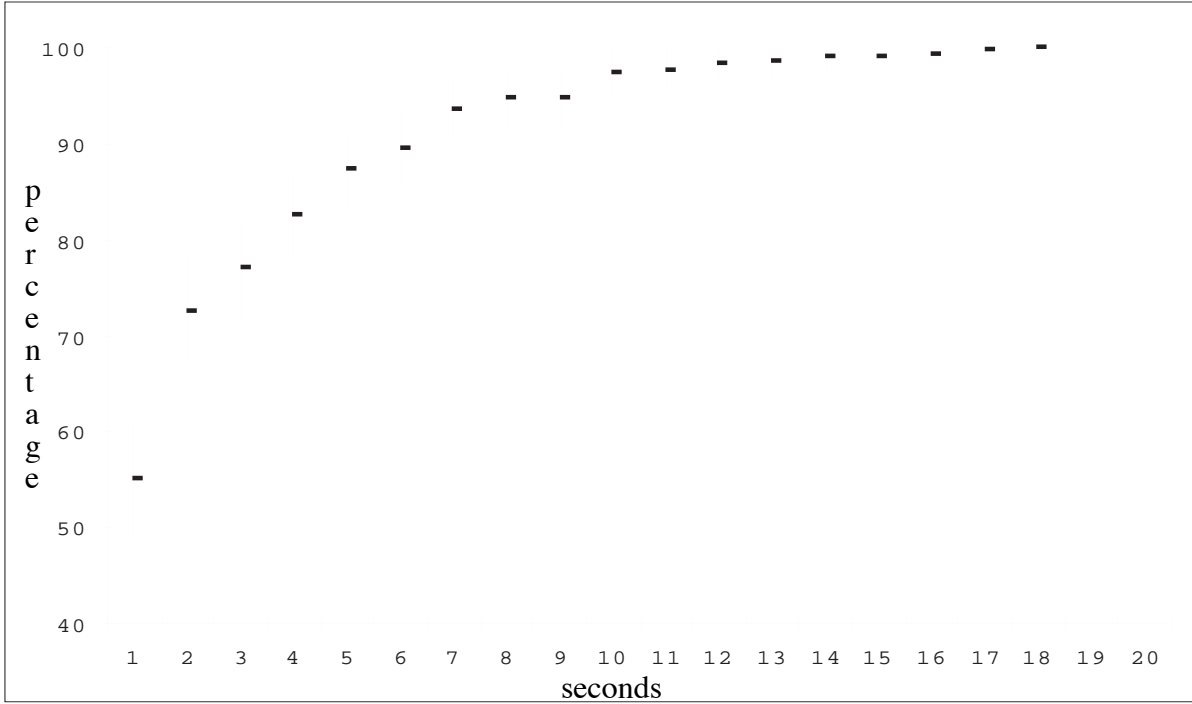

Figure 13. Availability of traffic data onboard the TSRV (percentage) versus delay (seconds).

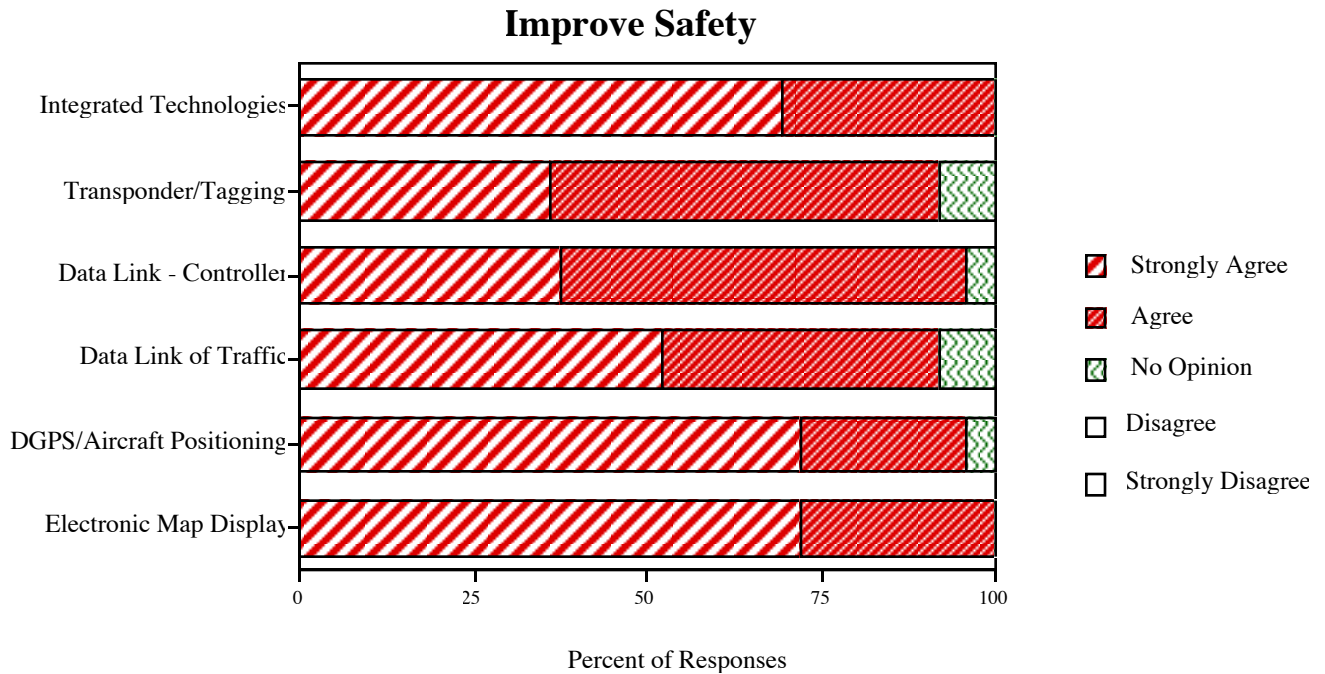

Figure 14. Visitor comments on demonstration technologies potential to improve safety.

Increase Capacity/Efficiency

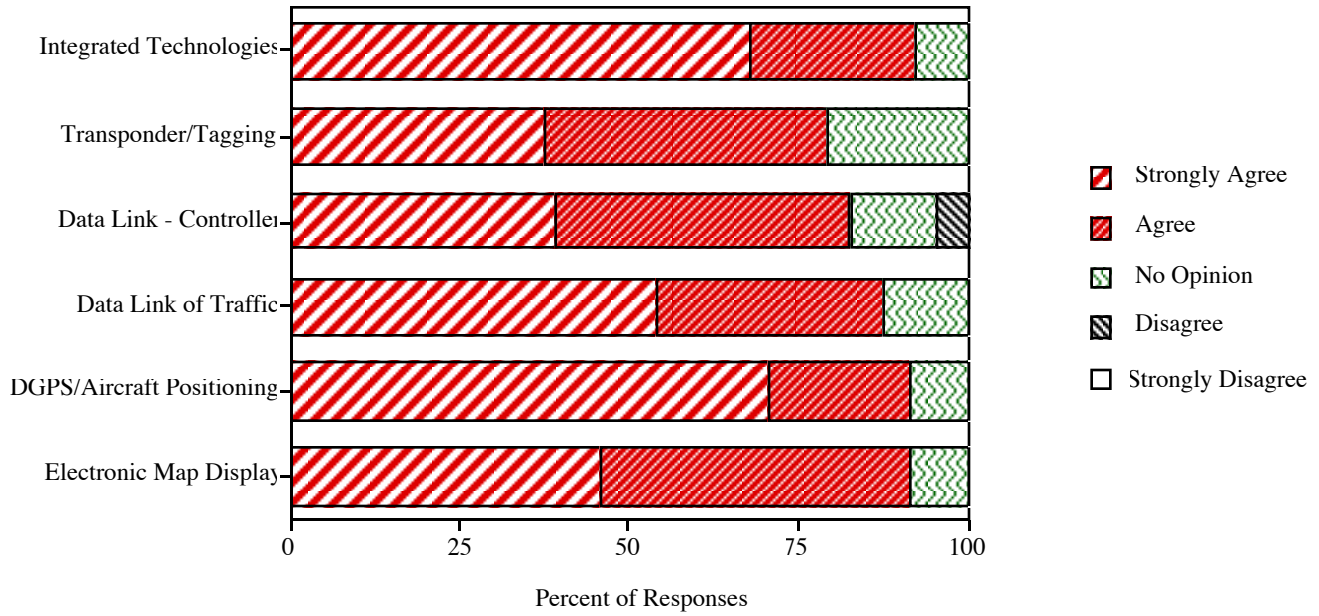

Figure 15. Visitor comments on demonstration technologies potential to increase capacity/efficiency.

Reduce Costs

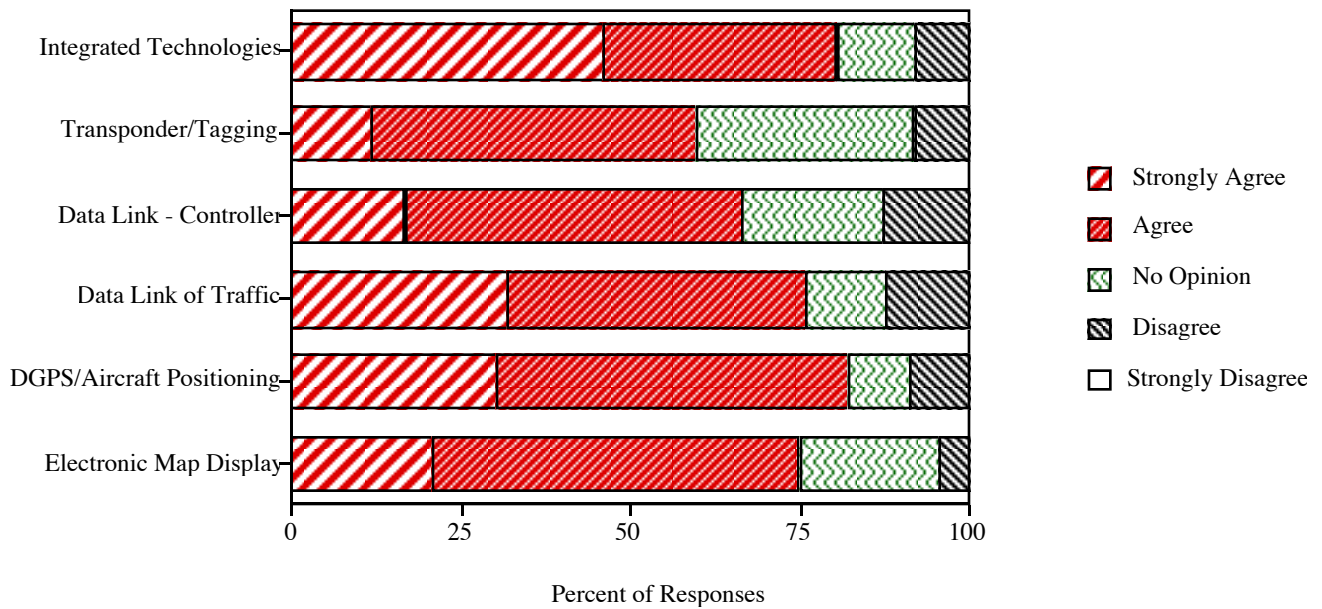

Figure 16. Visitor comments on demonstration technologies potential to reduce costs.

REPORT DOCUMENTATION PAGE			Form Approved OMB No. 0704-0188
Public reporting burden for this collection of information is estimated to average 1 hour per response, including the time for reviewing instructions, searching existing data sources, gathering and maintaining the data needed, and completing and reviewing the collection of information. Send comments regarding this burden estimate or any other aspect of this collection of information, including suggestions for reducing this burden, to Washington Headquarters Services, Directorate for Information Operations and Reports, 1215 Jefferson Davis Highway, Suite 1204, Arlington, VA 22202-4302, and to the Office of Management and Budget, Paperwork Reduction Project (0704-0188), Washington, DC 20503.			
1. AGENCY USE ONLY (Leave blank)	2. REPORT DATE February 1998	3. REPORT TYPE AND DATES COVERED Technical Memorandum	
4. TITLE AND SUBTITLE Flight Demonstration of Integrated Airport Surface Technologies for Increased Capacity and Safety		5. FUNDING NUMBERS 538-04-13-02	
6. AUTHOR(S) Denise R. Jones, Steven D. Young, Robert W. Wills, Kathryn A. Smith, Floyd S. Shipman, Wayne H. Bryant, and Dave E. Eckhardt, Jr.			
7. PERFORMING ORGANIZATION NAME(S) AND ADDRESS(ES) NASA Langley Research Center Hampton, VA 23681-2199		8. PERFORMING ORGANIZATION REPORT NUMBER L-17654	
9. SPONSORING/MONITORING AGENCY NAME(S) AND ADDRESS(ES) National Aeronautics and Space Administration Washington, DC 20546-0001		10. SPONSORING/MONITORING AGENCY REPORT NUMBER NASA/TM-1998-206930	
11. SUPPLEMENTARY NOTES			
12a. DISTRIBUTION/AVAILABILITY STATEMENT Unclassified-Unlimited Subject Category 03 Distribution: Standard Availability: NASA CASI (301) 621-0390		12b. DISTRIBUTION CODE	
13. ABSTRACT (Maximum 200 words) A flight demonstration was conducted to address airport surface movement area capacity and safety issues by providing pilots with enhanced situational awareness information. The demonstration presented an integration of several technologies to government and industry representatives. These technologies consisted of an electronic moving map display in the cockpit, a Differential Global Positioning system (DGPS) receiver, a high speed very high frequency (VHF) data link, an Airport Surface Detection Equipment (ASDE-3) radar, and the Airport Movement Area Safety System (AMASS). Aircraft identification was presented to an air traffic controller on an AMASS display. The onboard electronic map included the display of taxi routes, hold instructions, and clearances, which were sent to the aircraft via data link by the controller. The map also displayed the positions of other traffic and warning information, which were sent to the aircraft automatically from the ASDE-3/AMASS system. This paper describes the flight demonstration in detail, along with test results.			
14. SUBJECT TERMS airport surface operations, airport electronic map, LCD, data link, DGPS, ASDE-3 radar, AMASS, CDTI, CDPLC, flight testing		15. NUMBER OF PAGES 31	
		16. PRICE CODE A03	
17. SECURITY CLASSIFICATION OF REPORT Unclassified	18. SECURITY CLASSIFICATION OF THIS PAGE Unclassified	19. SECURITY CLASSIFICATION OF ABSTRACT Unclassified	20. LIMITATION OF ABSTRACT